

# HOLMES

GARAGE DOOR COMPANY®

*Excellence Since 1920™*



Settlers® Collection  
Design 13 with SQ24 Windows



*Leaders in*

STYLE ■ SELECTION ■ CRAFTSMANSHIP

Artistry® Collection AR2SP in Standard White with Long Rectangle Grille Windows



## STYLE, SELECTION & CRAFTSMANSHIP

Holmes Garage Door Company® offers a complete line of top quality doors including traditional raised panel doors, carriage house style doors, contemporary styles and commercial. With thousands of garage door designs to choose from, Holmes is Making it Easy to find and purchase the right door for your style!

### 3 THINGS TO CONSIDER WHEN CHOOSING YOUR NEXT GARAGE DOOR

**1 CURB APPEAL**  
A garage door can represent as much as 30% of your home's front façade. Homes with forward-facing garages see immediate curb appeal.

**2 VALUE**  
A new door can increase the value of your home by up to 4%.

**3 ENERGY EFFICIENCY & DURABILITY**  
If your garage is attached to your home, an energy-efficient door can do more than lower energy costs; insulated doors are also quieter and more durable.



# SAFETY, QUALITY & INNOVATION



### Deep Embossed Panels

Natural woodgrain texture and detailed raised panel design enhance door's beauty.



### Coped Edges

Custom crafted steel doors are designed with stylish beveled coped edges and decorative center grooves.



### Ultra-Grain<sup>®</sup> Finish

Ultra-Grain<sup>®</sup> delivers the best of both worlds—the realism of natural wood with the low maintenance and energy-efficient benefits of insulated steel.



### Decorative Windows

Inspired by current architectural trends, our windows add a new look to garage doors while complementing your home.



### Rust-Prevention System

Unsurpassed rust-prevention system creates a virtually maintenance-free surface.



### EZ-SET<sup>®</sup> Torsion Springs

Patented springs for easier, faster and safer installation. Eliminates the labor intensive and dangerous manual winding process.



### WARMER

Industry-leading R-values of up to 20.4 provide year-round comfort and energy savings.



### QUIETER

Just open a non-insulated garage door and then an Intellicore<sup>®</sup> door, and you'll hear a huge difference.



### STRONGER

A Holmes garage door featuring Intellicore<sup>®</sup> is nearly twice as strong as a polystyrene door of the same thickness, so it will look better, longer.



Look for this symbol on select products that feature Intellicore<sup>®</sup>.



Silver Series 5500 with Short Plain Windows

## 3 EASY STEPS TO CHOOSING YOUR NEW DOOR

### 1 CHOOSE YOUR DOOR STYLE

SPECIALTY

OR

STANDARD STEEL

See page 5 for examples of each door style.

### 2 CHOOSE YOUR CONSTRUCTION

#### DOOR CONSTRUCTION

	2" Polyurethane	1-3/8" Polyurethane	2" Polystyrene	1-3/8" Polystyrene	1-5/16" Polystyrene	Steel
<b>FEATURES</b>						
<b>intellicore</b>						
<b>Insulation Rating (R-value)/ Energy Efficiency</b>	18.4-20.4	12.9	9.0	6.5	6.3	N/A
<b>Security</b>						
<b>Noise Control</b>						
<b>Dent Resistance</b>						
<b>Warranty</b>	Limited Lifetime	Limited Lifetime	Limited Lifetime	Limited Lifetime	Limited Lifetime 25-year	Limited Lifetime 15-year

NOTE: Higher R-values mean increased energy efficiency, reduced noise, improved security and durability. Calculated door section R-value is in accordance with DASMA TDS-163.

### 3 CUSTOMIZE YOUR DOOR



Colors



Windows



Hardware

# RESIDENTIAL GARAGE DOOR COLLECTIONS

## SPECIALTY



**Contemporary Collection**  
ALUMINUM SERIES

Glass and Aluminum Design with Durable Construction  
**pgs. 6-7**



**Contemporary Collection**  
STEEL SERIES

Flush and Grooved Insulated Steel with Ultra-Grain® Finish Options  
**pgs. 8-9**



**Glenmoor™ Collection**  
LIMITED EDITION SERIES

Wood Look without the Wood Maintenance  
**pgs. 10-11**



**Glenmoor™ Collection**  
ULTRA-GRAIN® SERIES

Ultra-Grain® Beauty Meets Durability  
**pgs. 12-13**



**Settlers® Collection**

Carriage House Designs in Low Maintenance Steel and Composite  
**pgs. 14-15**



**Artistry® Collection**

Steel Carriage House Designs with Ultra-Grain® Finish Option  
**pgs. 16-17**

## SPECIALTY



**Lodgewood® Collection**

Wood Carriage House  
**pgs. 18-19**



**Decorative Hardware**

Authentic Carriage House Accents  
**pgs. 20-21**

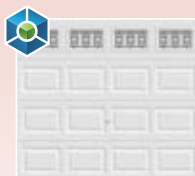

**Gold Series**

Insulated Steel Three-Layer Construction  
**pgs. 22-23**



**Silver Series**

Insulated Steel Two-Layer Construction  
**pg. 24**



**Bronze Series**

Non-Insulated Steel One-Layer Construction  
**pg. 24**



**Windows**

Designer Classics and Snap-In  
**pgs. 26-27**

## STANDARD STEEL

## COMMERCIAL GARAGE DOOR COLLECTIONS



**Sectional Doors**  
Commercial Sectional Steel  
**pgs. 28-29**



**Roll-Up Doors**  
Steel Roll-Up  
**pg. 30**

## OTHER INFORMATION TO KNOW

Safety, Quality & Innovation ..... pg. 3  
How-To-Measure Information..... pg. 32

# CONTEMPORARY COLLECTION

## ALUMINUM SERIES

Contemporary Collection Aluminum Series garage doors combine aluminum and glass to create a sleek, modern look. Many glass and panel combinations are available for varying degrees of privacy.

### DURABLE CONSTRUCTION

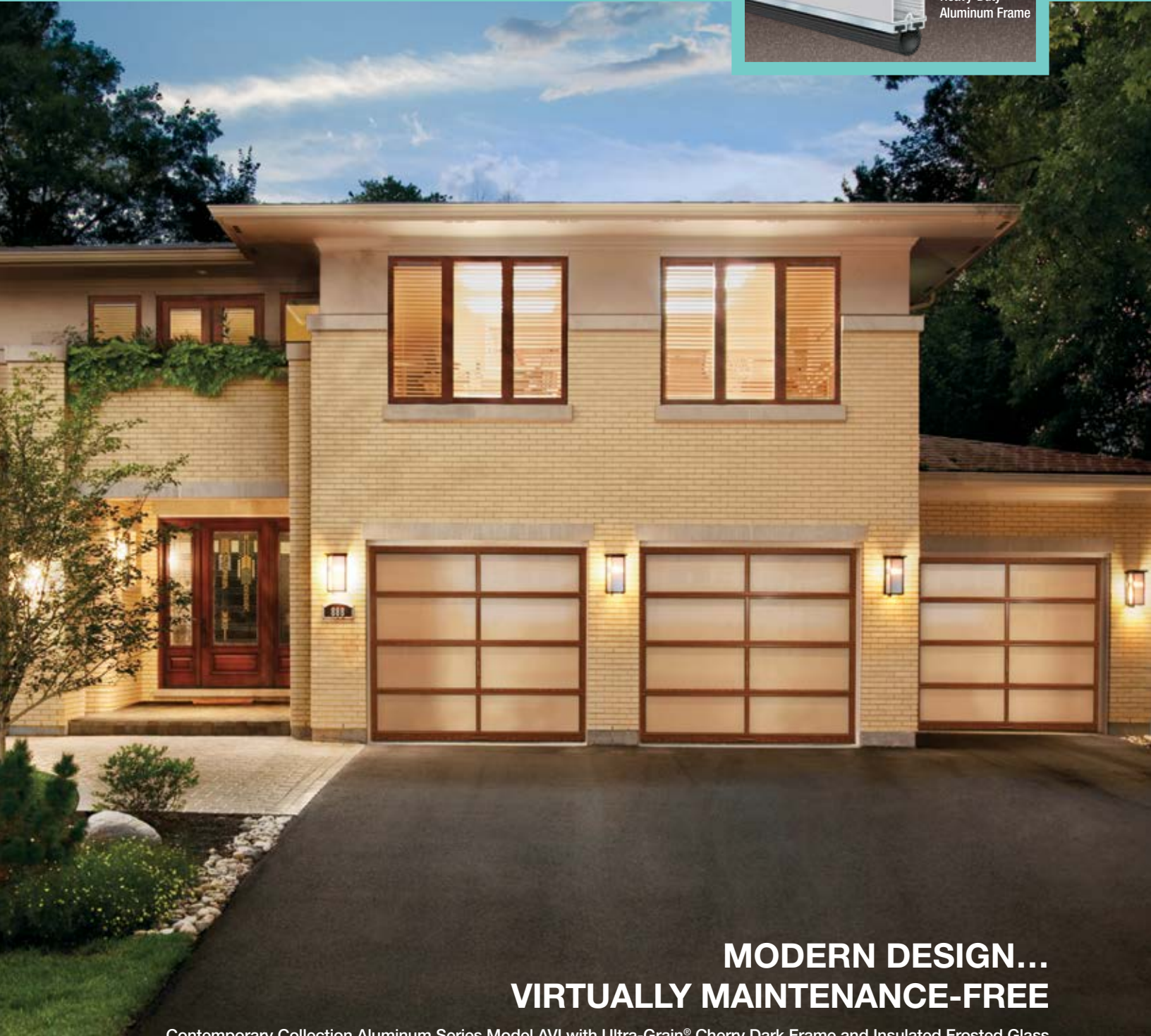
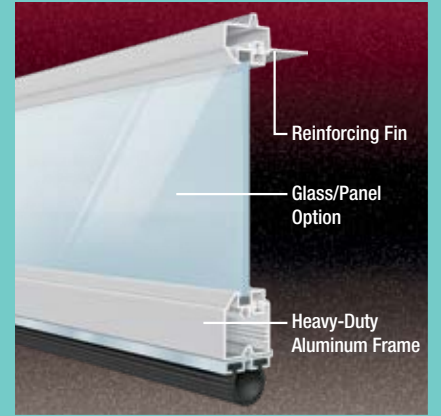

**MODERN DESIGN...  
VIRTUALLY MAINTENANCE-FREE**

Contemporary Collection Aluminum Series Model AVI with Ultra-Grain® Cherry Dark Frame and Insulated Frosted Glass

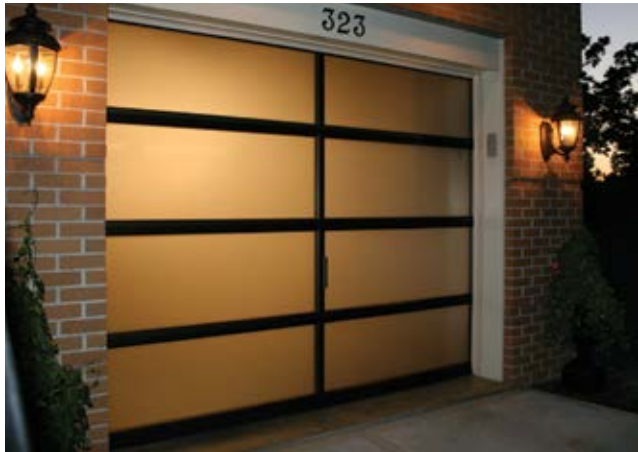

Contemporary Collection Aluminum Series Model AVI with Anodized Black Frame and Insulated Frosted Glass

## CONSTRUCTION AND FINISH

- 2-1/8" thick, virtually maintenance-free, long-lasting aluminum frame.
- Most glass is acrylic or tempered. Available in single pane (Model AV) or insulated (Model AVI). NOTE: Non-insulated 1/4" mirrored or white laminate is available on Model AVI only.
- Model AV available with acrylic or non-insulated 1/8" tempered clear or frosted glass, or solid aluminum panel options.
- Model AVI available with insulated tempered, non-insulated 1/4" mirrored or white laminate glass options.
- Tongue-and-groove joints and bottom weatherseal in a rust-resistant aluminum retainer helps seal out the elements.
- Frames come standard in Clear anodized or painted White, Bronze or Chocolate. Optional anodized Bronze, Black, Dark Bronze, Ultra-Grain® finishes or powder coated available (additional cost).

## WARRANTIES



## MODELS



AV (Non-Insulated)



AVI (Insulated)

## FRAME/SOLID PANEL COLOR OPTIONS



\*Colors available at an additional cost.

Due to the anodizing process, slight color variation may occur.

The use of "Bronze (Painted)" is recommended for a more consistent bronze finish color.

Powder coated custom colors available upon request; contact customer service for pricing.

## GLASS/PANEL OPTIONS

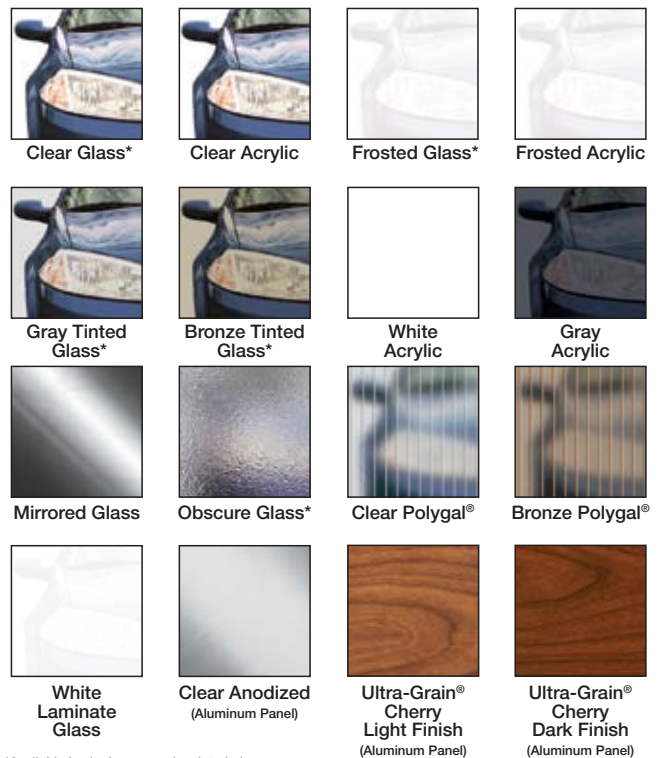

\*Available in single pane or insulated glass.

White laminated and mirrored glass not available insulated.

Panels can be aluminum to match the aluminum frame. Glass/acrylic panels

may be combined with aluminum panels. Custom glass and colors available.

Acrylic windows require special cleaning. Never use products that contain ammonia or petroleum products to clean acrylic. Please visit [holmesgaragedoor.com/acrylic](http://holmesgaragedoor.com/acrylic) for complete details.

# CONTEMPORARY COLLECTION

## STEEL SERIES

Contemporary Collection Steel Series garage doors complement contemporary and mid-century modern home styles. Doors are available with or without windows and with or without grooves.

### THREE-LAYER CONSTRUCTION



**MODERN BEAUTY...  
SIMPLE UPKEEP**

Contemporary Collection Steel Series Modern Flush panel in Ultra-Grain® Cypress Medium Finish



## CONSTRUCTION AND FINISH

- Four construction types to choose from:
  - 7202, 7201, 7208, 7205 and 7209 have 2" thick, three-layer **intellicores** polyurethane insulation (18.4 R-value).
  - 7132, 7131 and 7138 have 1-3/8" thick, three-layer **intellicores** polyurethane insulation (12.9 R-value).
  - 6202, 6201, 6208, 6205 and 6209 have 2" thick, three-layer polystyrene insulation (9.0 R-value).
  - 6132, 6131 and 6138 have 1-3/8" thick, three-layer polystyrene insulation (6.5 R-value).
- Many window options available.
- Ultra-Grain® Finish available on select three-layer models.

## DOOR STYLES

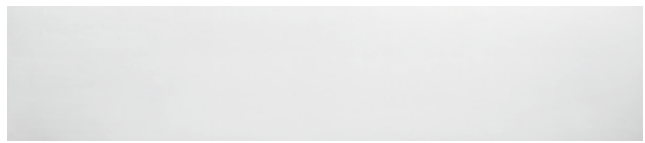

Modern Flush Panel – Models 7202, 7201, 7208, 7132, 7131, 7138, 6202, 6201, 6208, 6132, 6131 and 6138



Modern Grooved Panel – Models 7209, 7205, 6209 and 6205

## CONTEMPORARY WINDOW OPTIONS



Short Plain Windows  
down right side



Long Plain Windows  
in all panel locations

Contemporary window configurations are available in many design options, including windows in each section and down one side, short and long windows or windows in all sections. For doors with multiple window sections, the window locations must be the same in every section.

Door models offering these configurations utilize 24" and 21" section heights.

Note: Contemporary window configurations are described from inside the garage looking out.

## WARRANTIES



## COLOR OPTIONS



\*Not available on all models; contact customer service for availability.

† Popular in select markets, Glacier White is a brighter white.

Due to the printing process, colors may vary.

## WINDOWS



Plain



Designer Inserts



Designer Classics



Contemporary/Architectural Series

Additional window designs available; see pages 26–27.

# Glenmoor™

COLLECTION

LIMITED EDITION SERIES

The Limited Edition Series provides the natural beauty of wood with the durability and energy-efficient benefits of composite and steel.

## FIVE-LAYER CONSTRUCTION

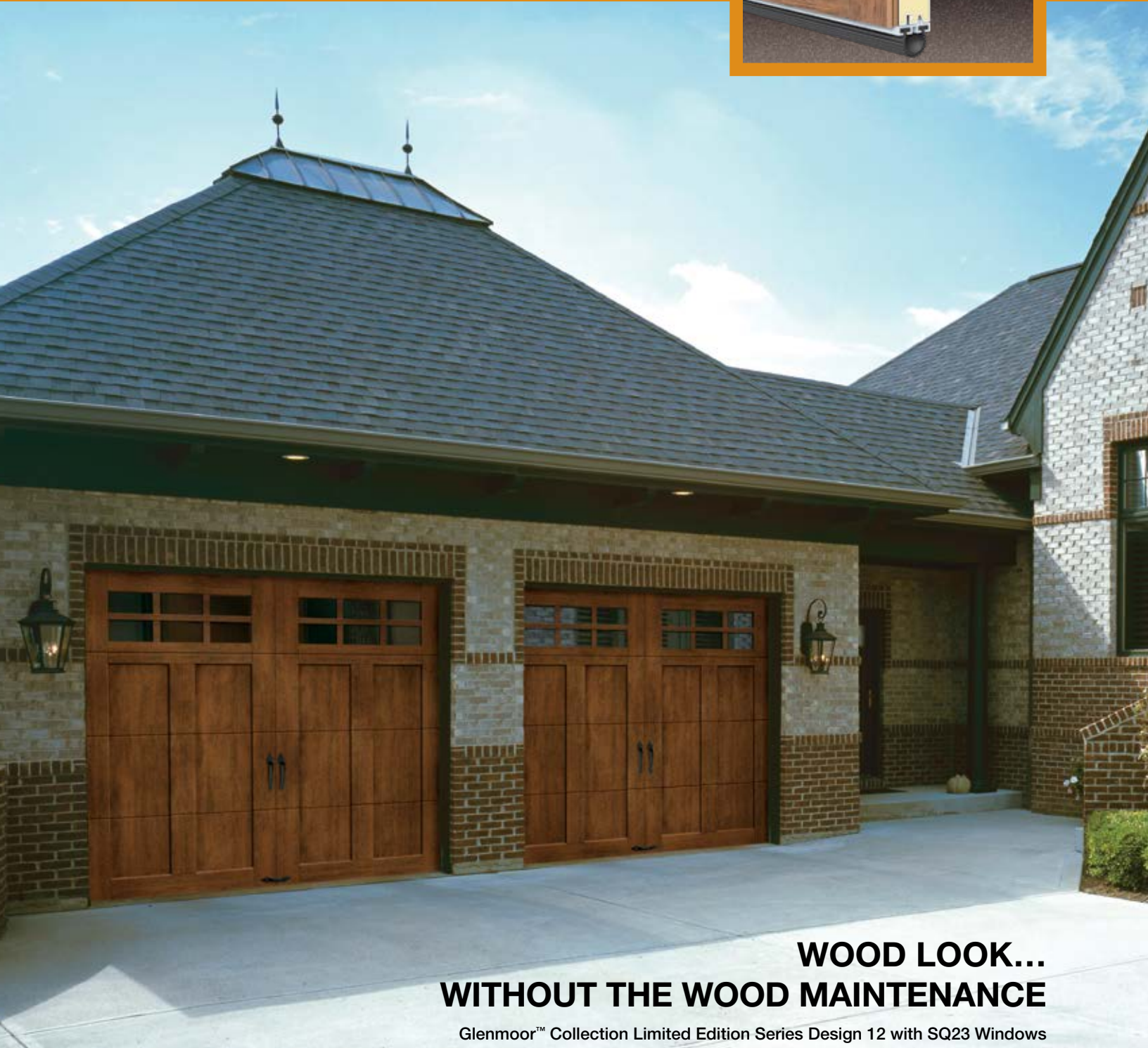

**WOOD LOOK...  
WITHOUT THE WOOD MAINTENANCE**

Glenmoor™ Collection Limited Edition Series Design 12 with SQ23 Windows

## CONSTRUCTION AND FINISH

- Five-layer **intellicores** polyurethane insulated, composite faux wood doors (20.4 R-value). Swing-out appearance – modern operation.
- Available in 15 door designs and 13 window or top sections for multiple door design options.
- Composite cladding options include Clear Cypress, Mahogany and Pecky Cypress. Composite overlay options include Clear Cypress and Mahogany.
- Windows are standard with 1/8" DSB glass. Frosted, seeded, obscure, rain and insulated glass options are also available.
- Attractive beveled edge clip-in grilles are removable for easy window cleaning.
- Premium grade hardware, rollers and track assure smooth, quiet, long-lasting operation.
- Comes factory finished in Walnut, Dark, Medium or Slate Finish; door can also be ordered in Whitewash Finish (Mahogany only) or primed for homeowners wishing to custom paint or stain their doors.

## WARRANTIES



## DECORATIVE HARDWARE

### INCLUDED



### OPTIONAL



Additional hardware options are available; see pages 20–21.

## DOOR DESIGNS

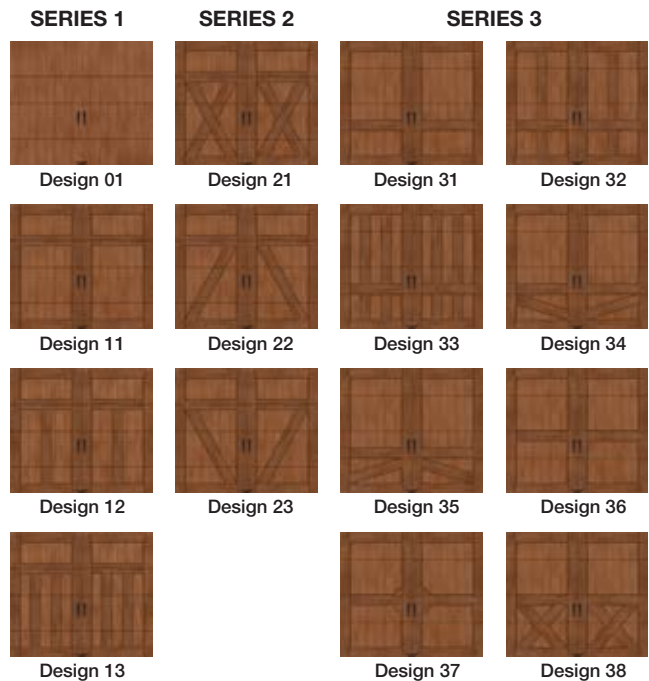

Doors shown in Dark Finish with Clear Cypress composite cladding and Clear Cypress composite overlay. Design 01 does not have an overlay.

## WINDOWS/TOP SECTION OPTIONS

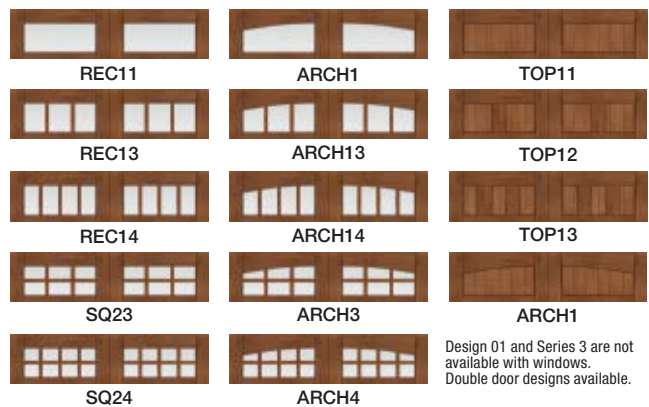

## MATERIAL DESIGN OPTIONS



Cladding and overlay material options may be mixed and matched.

## COLORS

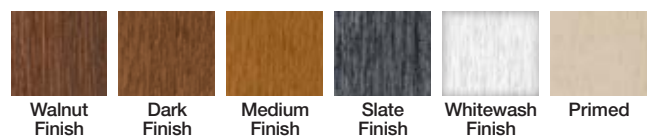

Cladding and overlays are finished in the same color.

Whitewash Finish available only on Mahogany cladding and overlays.

Doors can be ordered primed for those homeowners wishing to custom paint or stain their doors. Door stain color will vary slightly within a door due to finishing process.

Due to the printing process, colors may vary.

# Glenmoor™

COLLECTION

ULTRA-GRAIN® SERIES

Features a 2" Intellicore® polyurethane insulated steel base door with Ultra-Grain®, a durable and natural-looking woodgrain paint finish.

## FOUR-LAYER CONSTRUCTION



**ULTRA-GRAIN® ...  
BEAUTY MEETS DURABILITY**

Glenmoor™ Collection Ultra-Grain® Series Design 13 with ARCH3 Windows

## CONSTRUCTION AND FINISH

- Four-layer **intellico** polyurethane insulated, faux wood doors (18.4 R-value). Swing-out appearance – modern operation.
- Available in 14 door designs and 13 window or top sections for multiple door design options.
- Base steel options include Ultra-Grain® Cypress Walnut, Medium and Slate Finishes. Composite overlay available in Clear Cypress, stained to match base finish.
- Windows are standard with 1/8" DSB glass. Frosted, seeded, obscure, rain and insulated glass options are also available.
- Attractive beveled edge clip-in grilles are removable for easy window cleaning.
- Premium grade hardware, rollers and track assure smooth, quiet, long-lasting operation.

## WARRANTIES



## DECORATIVE HARDWARE

### INCLUDED

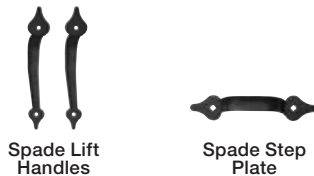

### OPTIONAL

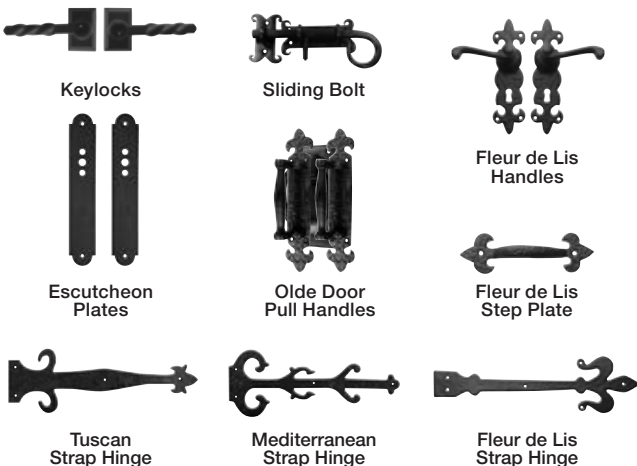

Additional hardware options are available; see pages 20–21.

## DOOR DESIGNS

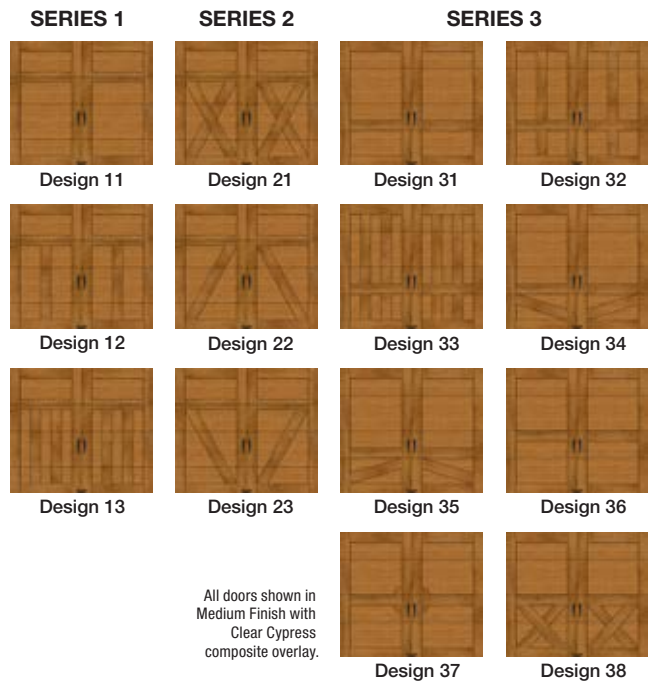

## WINDOWS/TOP SECTION OPTIONS

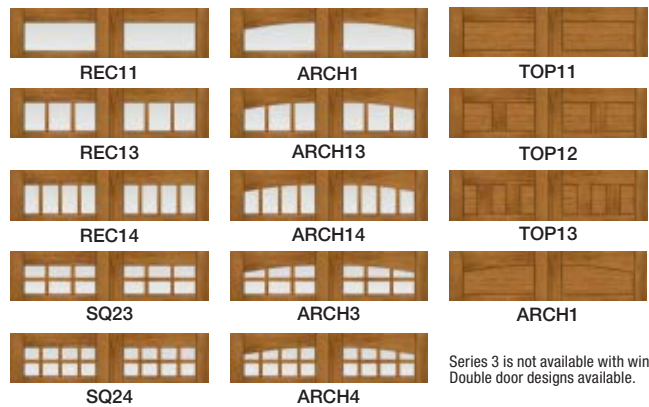

## MATERIAL DESIGN OPTIONS

### OVERLAY



Note: Cladding is not present on Ultra-Grain® Series Models.

## ULTRA-GRAIN® STEEL COLORS



Overlays and window grilles are finished in the same color as the Ultra-Grain® base door. Door stain color will vary slightly within a door due to finishing process. Due to the printing process, colors may vary.

# Settlers®

COLLECTION

Settlers® Collection doors provide a traditional carriage house appearance with upward-acting functionality and durable construction.

## FOUR-LAYER CONSTRUCTION

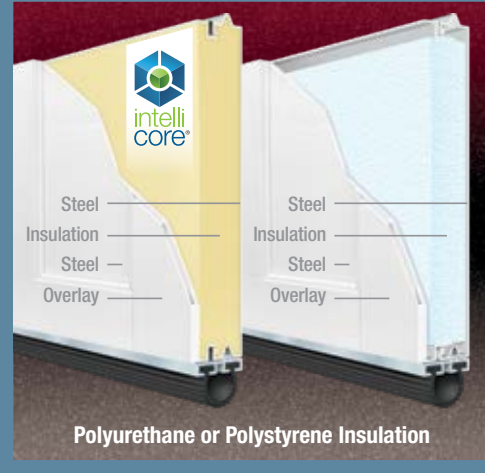

**CARRIAGE HOUSE DESIGNS...  
DURABLE, RELIABLE CONSTRUCTION**

Settlers® Collection SF22 with SQ23 Windows

## CONSTRUCTION AND FINISH

- Base door has a natural woodgrain texture, painted with a baked-on primer and polyester top coat.
- Detailed beveled, coped-edge overlay.
- Windows with complete overlay and true arch designs are available in double strength, frosted, seeded, rain and insulated glass. Grilles are removable for ease of cleaning.
- Includes automatic opener reinforcement.
- EZ-SET® torsion springs standard on most sizes.
- SXU models have 2" **intellicores** polyurethane insulation (18.4 R-value).
- SX models have 2" polystyrene insulation (9.0 R-value).
- SF models have 1-3/8" polystyrene insulation (6.5 R-value).

## WARRANTIES

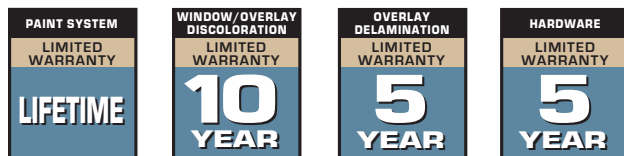

## DECORATIVE HARDWARE

### INCLUDED

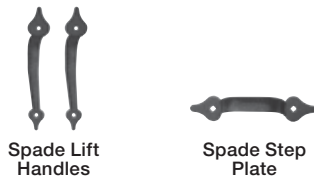

### OPTIONAL

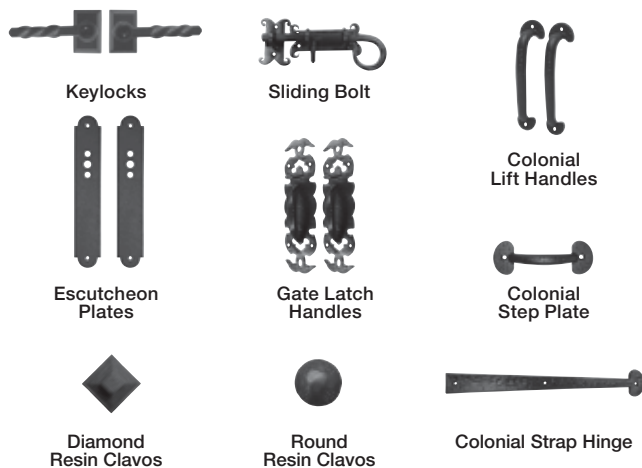

Additional hardware options are available; see pages 20–21.

## DOOR DESIGNS

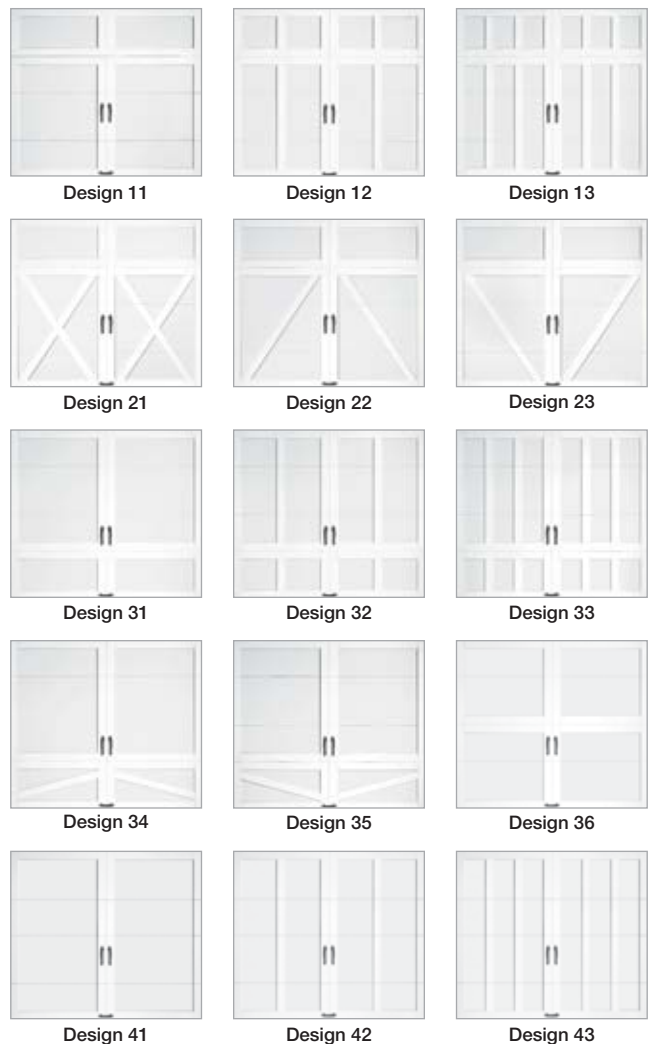

## WINDOWS/TOP SECTION OPTIONS

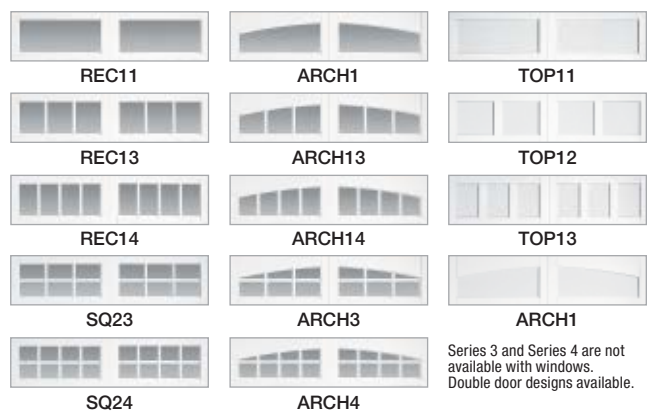

## BASE DOOR/OVERLAY COLOR OPTIONS

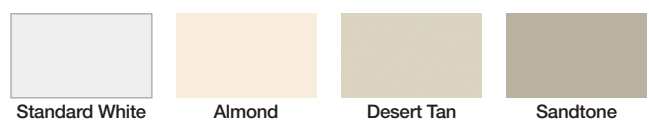

**Note:** Door and overlay colors can be mixed and matched. Due to the printing process, colors may vary.

# Artistry® COLLECTION

Artistry® Collection doors create an authentic carriage house look at an affordable price.

## THREE, TWO & ONE-LAYER CONSTRUCTION

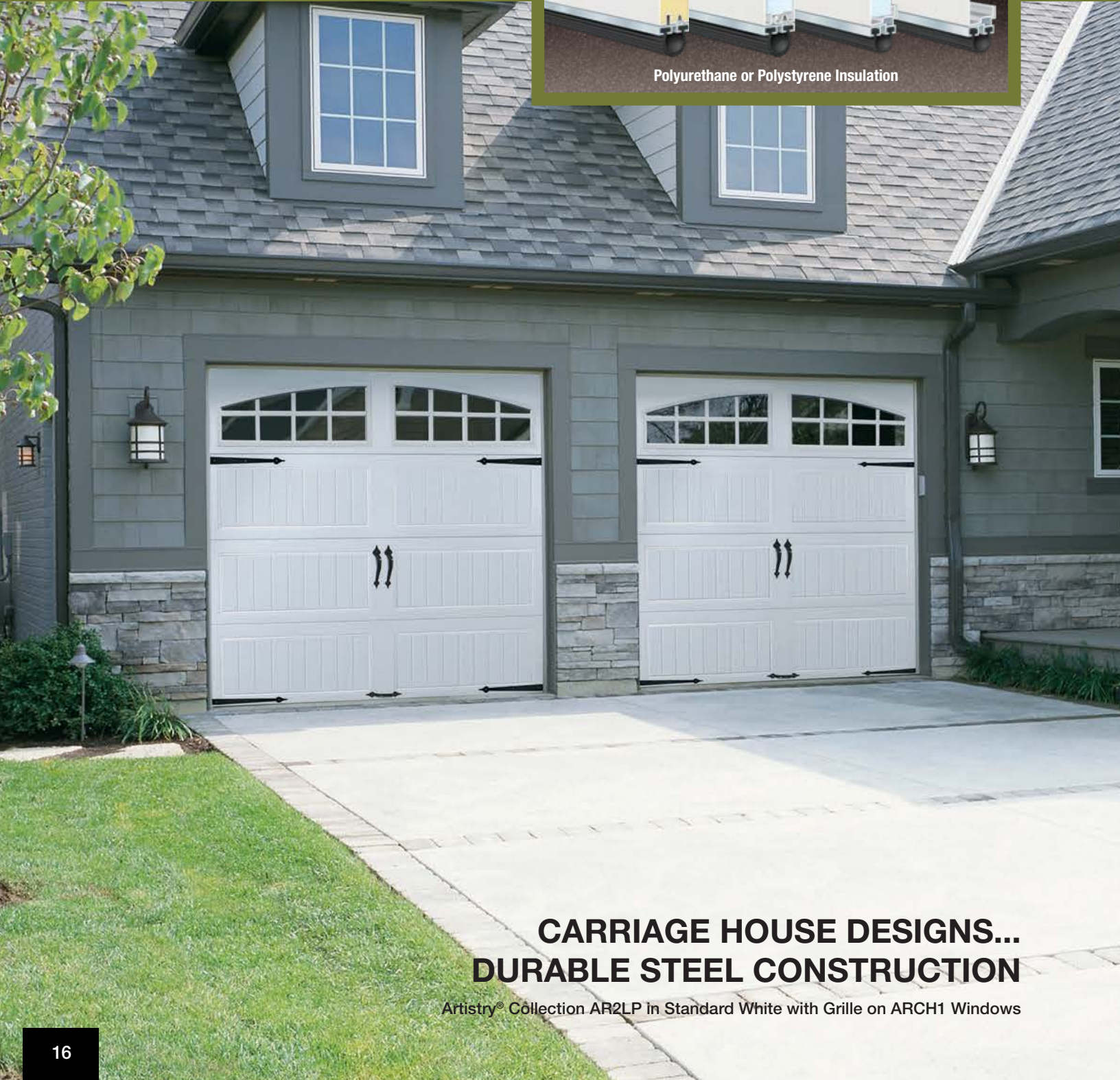

## CARRIAGE HOUSE DESIGNS... DURABLE STEEL CONSTRUCTION

Artistry® Collection AR2LP in Standard White with Grille on ARCH1 Windows



## CONSTRUCTION AND FINISH

- Deep embossed stamped steel carriage house designs in short and long panel styles.
- Six construction types to choose from:
  - 2" thick, three-layer **intellicores** polyurethane insulation (18.4 R-value)
  - 1-3/8" thick, three-layer **intellicores** polyurethane insulation (12.9 R-value)
  - 2" thick, three-layer polystyrene insulation (9.0 R-value)
  - 1-3/8" thick, three-layer polystyrene insulation (6.5 R-value)
  - 24 or 25 gauge, 1-5/16" thick, two-layer polystyrene insulation (6.3 R-value)
  - 24 or 25 gauge, one-layer non-insulated
- Note: 25 gauge available only in short panel.*
- Many window options available.
- Ultra-Grain® Finish available on select three-layer models.
- All models can be painted to match your home's exterior. Please visit <http://info.garagedoors.com/lrv> for paint instructions on Intellicore® models.

## WARRANTIES

PAINT SYSTEM LIMITED WARRANTY	PAINT SYSTEM LIMITED WARRANTY	WINDOW LIMITED WARRANTY	HARDWARE/SPRINGS LIMITED WARRANTY
<b>LIFETIME</b>	<b>15 YEAR</b>	<b>10 YEAR</b>	<b>3 YEAR</b>
AR2SU/AR2LU/ AR1SU/AR1LU AR2SP/AR2LP/ AR1SP/AR1LP AR4SV/AR4LV/ AR4S/AR4L	AR5SV/AR5S	ALL MODELS	ALL MODELS

## DECORATIVE HARDWARE

### INCLUDED

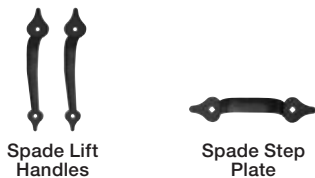

### OPTIONAL

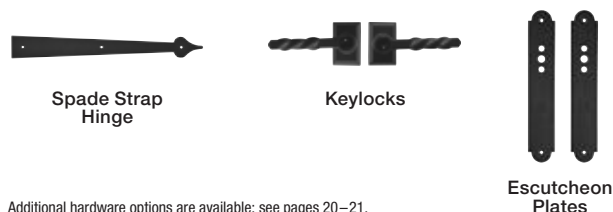

Additional hardware options are available; see pages 20–21.

## DOOR DESIGNS

Single door width shown

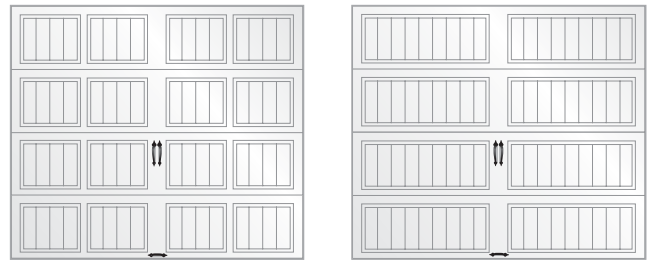

**Three-Layer**  
AR2SU, AR1SU,  
AR2SP, AR1SP

**Two-Layer**  
AR4SV, AR5SV

**One-Layer**  
AR4S, AR5S

**Three-Layer**  
AR2LU, AR1LU,  
AR2LP, AR1LP

**Two-Layer**  
AR4LV

**One-Layer**  
AR4L

## WINDOWS/TOP SECTION OPTIONS

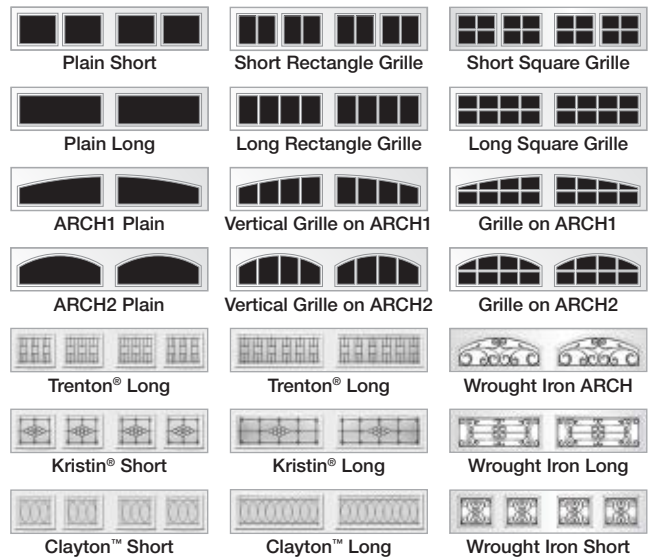

Double door designs available.

Acrylic windows require special cleaning. Never use products that contain ammonia or petroleum products to clean acrylic. Please visit [holmesgaragedoor.com/acrylic](http://holmesgaragedoor.com/acrylic) for complete details.

## COLOR OPTIONS

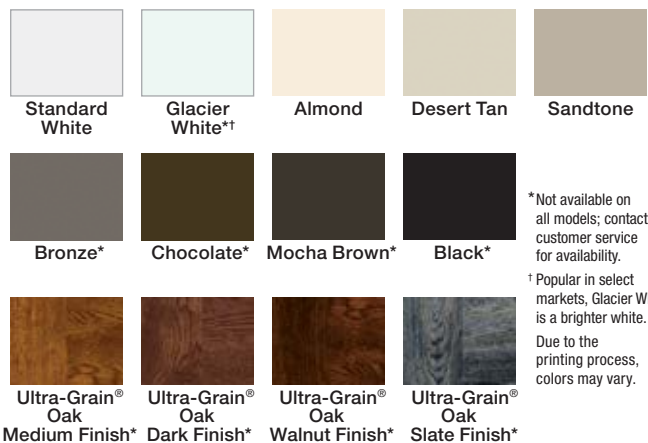

\* Not available on all models; contact customer service for availability.

\*\* Popular in select markets, Glacier White is a brighter white. Due to the printing process, colors may vary.

# Lodgewood<sup>®</sup> COLLECTION

The Lodgewood<sup>®</sup> Collection combines authentic wood designs with the functionality of an upward-acting sectional door.

HANDCRAFTED  
TWO-LAYER CONSTRUCTION



**EXTRAORDINARY CRAFTSMANSHIP...  
IMPRESSIVE APPEARANCE**

Lodgewood<sup>®</sup> Collection Design 2 with SQ24 windows

## CONSTRUCTION AND FINISH

- Handcrafted two-layer, non-insulated wood doors in authentic carriage house designs. Swing-out appearance – modern operation.
- Available in three wood species. All stain-grade wood rails, stiles and panels are made from Redwood, Cedar or Hemlock. Hemlock (paint grade and grooved) doors have Hemlock stiles and rails with exterior grade MDO plywood panels.
- 1/4" thick imported Luan interior backer glued to stiles and rails.
- True divided windows are standard with 1/8" DSB glass. Specialty glass options available.
- All doors can be factory primed or finish painted white. Factory stain available for stained-grade wood species (additional cost).

## WARRANTIES



## DECORATIVE HARDWARE

### INCLUDED

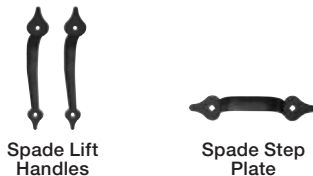

### OPTIONAL



## OPTIONAL FACTORY STAINING\*

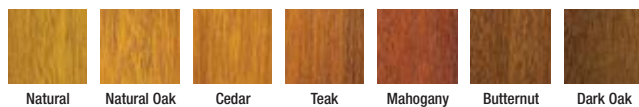

Not all wood types stain equally and all stain colors will vary in appearance on all wood types. Variations in color will occur from printed material to actual doors, or even from door-to-door. \*Additional cost.

Proper care and maintenance are imperative to the appearance, longevity and performance of all wood doors. Doors must be painted or stained on all six sides prior to installation. Failure to follow the installation and maintenance instructions will void the warranty. Please refer to the installation and maintenance manual for additional information about caring for a wood door.

## DOOR DESIGNS

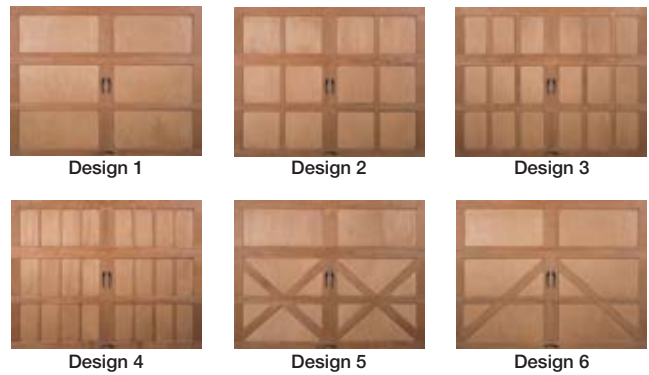

## WINDOWS/TOP SECTION OPTIONS

### SINGLE CAR DOOR WIDTHS



### DOUBLE CAR DOOR OPTIONS

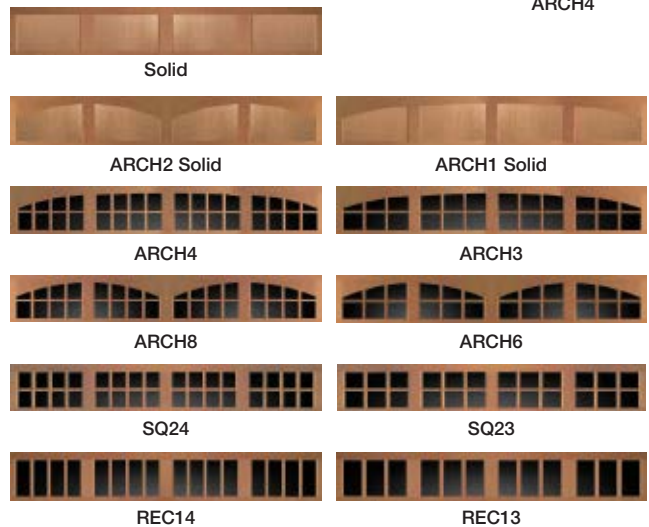

## MATERIAL OPTIONS

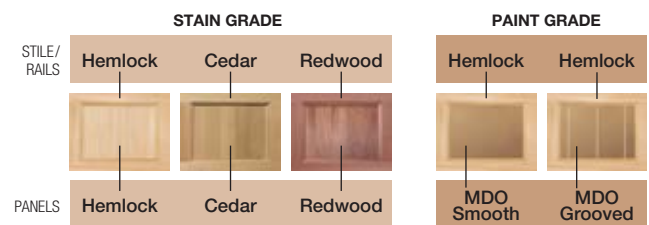

Paint grade and grooved doors cannot be stained.



Hardware Description <i>Numbers below correspond with images on page 21</i>		Collection Availability				
		CONTEMPORARY COLLECTION ALUMINUM SERIES	GLENMOOR™ COLLECTION	SETTLERS® COLLECTION	ARTISTRY® COLLECTION	LODGEWOOD® COLLECTION
<b>INCLUDED</b>						
1	Spade Lift Handles		✓	✓	✓	✓
2	Spade Step Plate		✓	✓	✓	✓
<b>OPTIONAL</b>						
3	Spade Strap Hinge*		✓	✓	✓	✓
4	Twisted "L" Handles		✓	✓	✓	✓
5	Twisted "T" Handle				✓	
6	Escutcheon Plate(s)		✓	✓	✓	✓
7	Diamond Resin Clavos*		✓	✓	✓	✓
8	Round Resin Clavos*		✓	✓	✓	✓
9	Ring Door Knocker		✓	✓		✓
10	Ring Knocker with Plate		✓	✓		✓
11	Lion's Head Door Knocker		✓	✓		✓
12	Decorative Handles with Keyhole		✓	✓		✓
13	Sliding Bolt		✓	✓		✓
14	Spear Lift Handles		✓	✓	✓	✓
15	Spear Step Plate		✓	✓	✓	✓
16	Spear Strap Hinge*		✓	✓	✓	✓
17	Fleur de Lis Handles		✓	✓		✓
18	Fleur de Lis Step Plate		✓	✓		✓
19	Fleur de Lis Strap Hinge**†		✓	✓		✓
20	Colonial Lift Handles		✓	✓	✓	✓
21	Colonial Step Plate		✓	✓	✓	✓
22	Colonial Strap Hinge*		✓	✓	✓	✓
23	Olde Door Pull Handles		✓	✓	✓	✓
24	Gate Latch Handles		✓	✓	✓	✓
25	Mediterranean Strap Hinge**†		✓			
26	Tuscan Strap Hinge**†		✓			
27	Aluminum Grip Handles	✓				

\*Door may not open properly if installed near the top depending on opening dimensions and lift type.

†Hardware may not fit on all door designs.

# DECORATIVE HARDWARE

Attractive black powder coated handles and step plates are provided standard to further enhance the design of the door. Optional decorative hardware, including handles, operable L-keylocks, strap hinges, door knockers and studs, are also available.

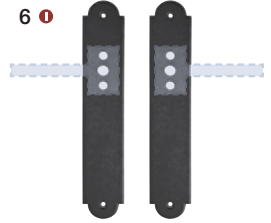
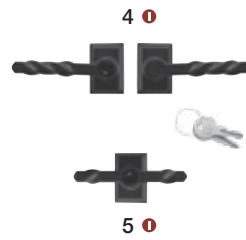

\*Complements Spade Lift Handles and Spade Step Plate.

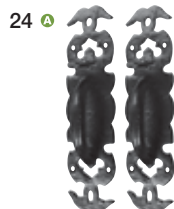

Ⓔ = Steel Construction  
 Ⓡ = Cast Iron Construction  
 Ⓐ = Aluminum Construction  
 Ⓡ = Resin Construction

# GOLD SERIES

Three-layer construction provides maximum energy efficiency, the quietest operation and superior durability.

## THREE-LAYER CONSTRUCTION



## STEEL + INSULATION + STEEL

Gold Series 7200 in Desert Tan with Colonial 509 Windows

## CONSTRUCTION AND FINISH

- Elegant raised and long panel designs for improved curb appeal.
- Three-layer construction provides maximum energy efficiency, the quietest operation and superior durability.
- Prefinished, stucco textured flush interior for beauty inside and out.
- 7200 and 7203 have 2" thick **intellico<sup>re</sup>** polyurethane insulation (18.4 R-value).
- 7130 and 7133 have 1-3/8" thick **intellico<sup>re</sup>** polyurethane insulation (12.9 R-value).
- 6200 and 6203 have 2" thick polystyrene insulation (9.0 R-value).
- 6130 and 6133 have 1-3/8" thick polystyrene insulation (6.5 R-value).
- All models can be painted to match your home's exterior. Please visit <http://info.garagedoors.com/lrv> for paint instructions on Intellicore® models.

## DOOR STYLES



Elegant Raised Panel – Models 7200, 7130, 6200 and 6130



Elegant Long Panel – Models 7203, 7133, 6203 and 6133



Decorative panel edging and natural embossed woodgrain texture improve appearance close-up and from the curb.

## WARRANTIES



## COLOR OPTIONS



\* Not available on all models; contact customer service for availability.

† Popular in select markets, Glacier White is a brighter white.

## WINDOWS



Plain



Designer Inserts



Designer Classics



Contemporary/Architectural Series

Additional window designs available; see pages 26–27.

# SILVER SERIES BRONZE SERIES

Residential garage doors are available with or without insulation.

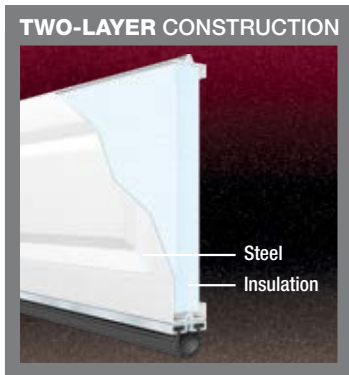

## CONSTRUCTION AND FINISH

- Two-layer construction for energy efficiency and enhanced durability.
- Thick vinyl-backed polystyrene insulation for added energy efficiency.
- 5500 and 5503 have 1-5/16" thick polystyrene insulation (6.3 R-value).



## CONSTRUCTION AND FINISH

- One-layer steel construction is durable and economical.
- Traditional raised and long panel designs for improved curb appeal.
- Woodgrain textured short and long raised panel designs complement traditional home styles.

## DOOR STYLES



Traditional Raised Panel – Models 5500, 4200



Traditional Long Panel – Models 5503, 4203



Decorative panel edging and natural embossed woodgrain texture improve appearance close-up and from the curb.

## COLOR OPTIONS



Standard White Almond Desert Tan Sandtone Chocolate

Due to the printing process, colors may vary.

## WINDOWS



Plain



Designer Inserts



Designer Classics

Additional window designs available; see pages 26–27.

## WARRANTIES



5500/5503



4200/4203



ALL MODELS



ALL MODELS



# RESIDENTIAL TRACK OPTIONS

Determine the right track option for your new residential garage door from the options below.

## STANDARD RADIUS

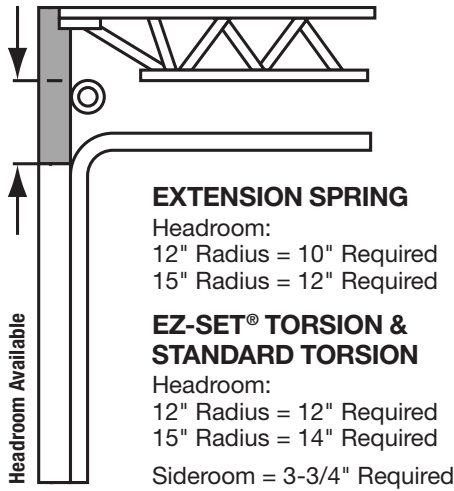

## LOW HEADROOM FRONT MOUNT

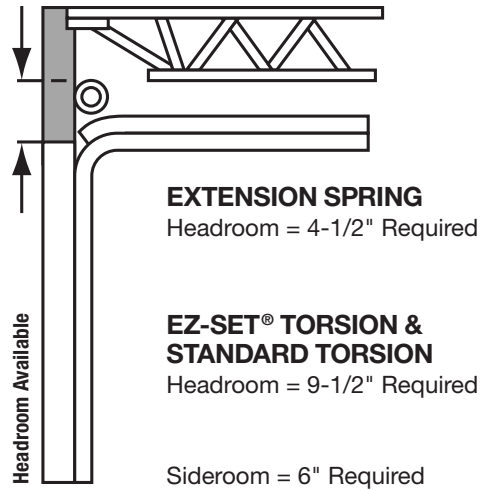

## HIGH LIFT

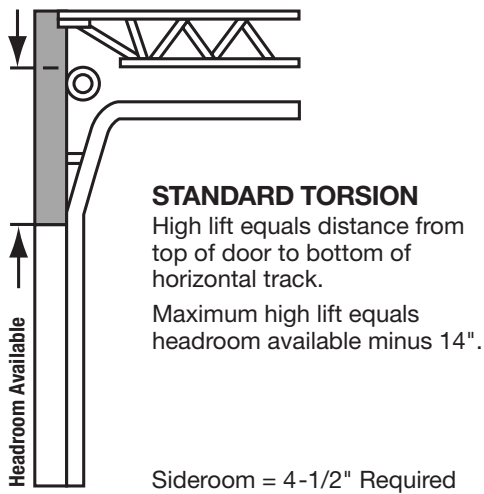

## LOW HEADROOM REAR MOUNT

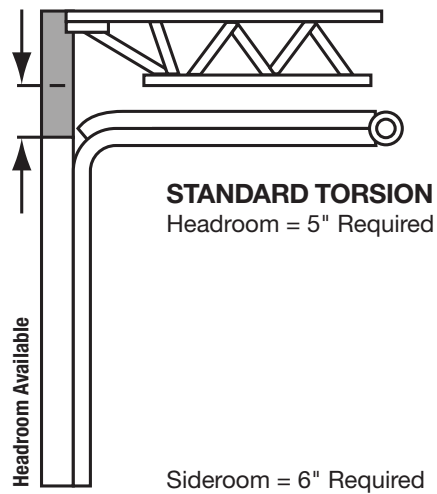

Headroom = Top of door to nearest obstruction (truss, ceiling or light fixture).  
 Up to 3" of additional headroom may be required for a trolley door opener.

# WINDOW SELECTION GUIDE

Add a personal touch with designer window lites.

Available on Contemporary Collection Steel Series, GOLD, SILVER and BRONZE Series.

## PLAIN

Single pane, double-strength glass.



Short



Long

## DESIGNER INSERTS

Dress up our plain windows with our UV-protected, color-matched Designer Inserts. They simply snap in over our plain window.



Charleston 508



Charleston 608



Colonial 509



Stockton 612



Sunset 502 (7', 7'6", 12' widths only)



Prairie 510



Prairie 610



Sunset 501 (8', 9', 12', 16', 17', 18', 20' widths only)



Madison 611



Sunset 503 (8', 9', 16', 17', 18' widths only)



Madison Arch 613



Sunset 504 (14', 15', 15'6" widths only)



Sunset 601



Sunset 505 (16', 17', 18' widths only)



Sunset 603



Sunset 506 (10', 20' widths only)



Sunset 605 (15', 16', 17', 18' widths, long panel doors only)

## DESIGNER CLASSICS

For a touch of elegance, choose our Designer Classics options.



Trenton® Short



Kristin® Short



Roselle® Short



Trenton® Long



Kristin® Long



Roselle® Long



Carlisle® Short



Tuscany Short\*



Orleans Short\*

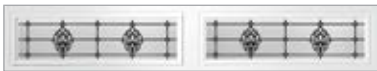

Carlisle® Long



Tuscany Long\*



Orleans Long\*

\*Available non-insulated only.

## CONTEMPORARY/ARCHITECTURAL SERIES

For a larger viewing area, choose our Contemporary/Architectural Series options.



Plain Short



Short with Rectangular Grilles



Short with Square Grilles



Plain Long



Long with Rectangular Grilles



Long with Square Grilles



ARCH1 Plain



Vertical Grille on ARCH1



Grille on ARCH1



ARCH2 Plain



Vertical Grille on ARCH2



Grille on ARCH2



Trenton® Short



Trenton® Long



Wrought Iron Short\*



Kristin® Short



Kristin® Long



Wrought Iron Long\*



Clayton™ Short



Clayton™ Long



Wrought Iron ARCH\*

\*Available non-insulated only.

Acrylic windows require special cleaning. Never use products that contain ammonia or petroleum products to clean acrylic. Please visit [holmesgaragedoor.com/acrylic](http://holmesgaragedoor.com/acrylic) for complete details.

# GOLD SERIES

Three-layer construction provides a durable, quiet and energy-efficient door for your commercial applications.



## CONSTRUCTION AND FINISH

- 2" or 1-3/8" thick **intellcore** polyurethane insulation (18.4, 12.9 R-values, respectively).
- 2" or 1-3/8" thick polystyrene insulation (9.0, 6.5 R-values, respectively).
- Insulation is pressure bonded between two layers of steel.
- Superior strength and durability.
- Maximum energy efficiency and quietest operation.
- Two panel styles and nine colors available.
- Commercial-duty rollers.
- Heavy-duty commercial track, hardware and springs.

## WINDOWS



24" x 8"



24" x 12"



Full Vision Section



Plain Short

See pages 26–27 for additional window availability.



## DOOR STYLES

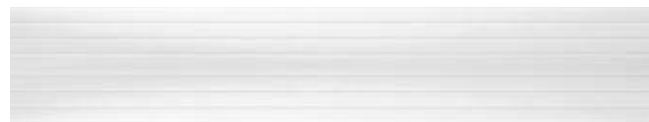

Holmes 240U, 240, 210U, 210 Shallow Ribbed Panel



Holmes 250G, 230G Elegant Raised Panel

## COLOR OPTIONS



Due to the printing process, colors may vary.  
Colors not available on all models; contact customer service for availability.

# SILVER SERIES BRONZE SERIES

Commercial ribbed doors are available with or without insulation.



## CONSTRUCTION AND FINISH

- 1-3/8" thick, steel-backed polystyrene insulation (6.6 R-value) is behind an exterior steel skin.
- Added energy efficiency.
- Commercial-duty rollers.
- Heavy-duty commercial track, hardware and springs.



## CONSTRUCTION AND FINISH

- Durable and economical steel construction.
- Commercial-duty rollers.
- Heavy-duty commercial track, hardware and springs.



## DOOR STYLES



Holmes 224V, 224S, 225V, 225S Ribbed Panel



Holmes 224, 225 Ribbed Panel

## COLOR OPTIONS



Standard White



Chocolate

Due to the printing process, colors may vary.

## WINDOWS



24" x 6"



24" x 12"



Full Vision Section



**Model 270H**

# GOLD SERIES

- Trucking Terminals
- Post Frame Buildings
- Light Industrial Warehousing
- Job Site Trailers
- Farm Machinery Storage Sheds
- Available in sizes 2' wide x 2' high through 18' wide x 18' high



**Model 260H**

# BRONZE SERIES

- Yard Barns
- Mini-Warehouses
- Storage Sheds
- Boat Houses
- Other Light-Duty Applications
- Available in sizes 2' wide x 2' high through 12' wide x 14' high

## SILICONIZED POLYESTER PAINT\*

20 finishes complement any building

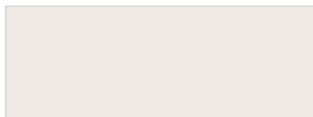

Glossy White

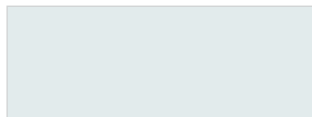

White



Silhouette Gray



Light Stone



Desert Tan



Sandstone

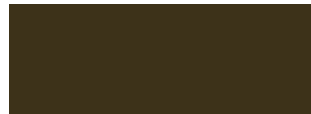

Bronze

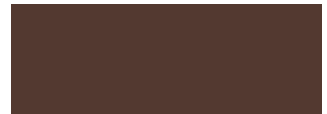

Continental Brown



Cedar Red



Valentine Red



Tangerine



Sunset Orange



Marine Green



Teal



Dark Teal



Fern Green



Evergreen



Forest Green



Royal Blue



Polar Blue

\*Due to the printing process, colors may vary.

# COMMERCIAL TRACK OPTIONS

Determine the right track option for your new commercial garage door from the options below.

## STANDARD RADIUS

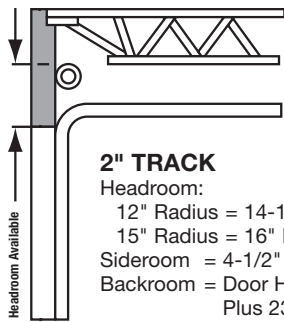

### 2" TRACK

Headroom:  
 12" Radius = 14-1/2" Required  
 15" Radius = 16" Required  
 Sideroom = 4-1/2" Required  
 Backroom = Door Height  
 Plus 23" Required

### 3" TRACK

Headroom = 18" Required  
 Sideroom = 5-1/2" Required  
 Backroom = Door Height  
 Plus 25" Required

## LOW HEADROOM FRONT MOUNT

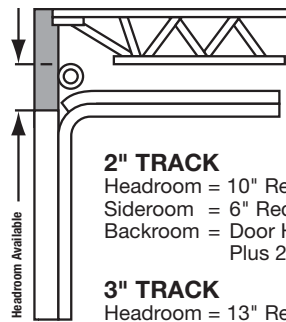

### 2" TRACK

Headroom = 10" Required  
 Sideroom = 6" Required  
 Backroom = Door Height  
 Plus 23" Required

### 3" TRACK

Headroom = 13" Required  
 Sideroom = 6-1/2" Required  
 Backroom = Door Height  
 Plus 25" Required  
*(1,200 lb. limit on door weight)*

## LOW HEADROOM REAR MOUNT

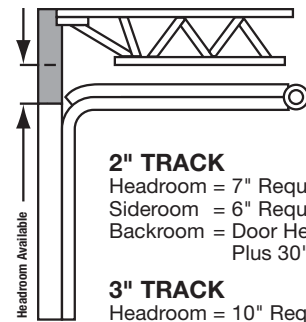

### 2" TRACK

Headroom = 7" Required  
 Sideroom = 6" Required  
 Backroom = Door Height  
 Plus 30" Required

### 3" TRACK

Headroom = 10" Required  
 Sideroom = 6-1/2" Required  
 Backroom = Door Height  
 Plus 32" Required  
*(800 lb. limit on door weight)*

## VERTICAL LIFT

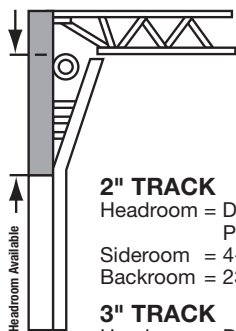

### 2" TRACK

Headroom = Door Height  
 Plus 12" Required  
 Sideroom = 4-1/2" Required  
 Backroom = 23" Required

### 3" TRACK

Headroom = Door Height  
 plus 12" Required  
 Sideroom = 5-1/2" Required  
 Backroom = 23" Required

## HIGH LIFT

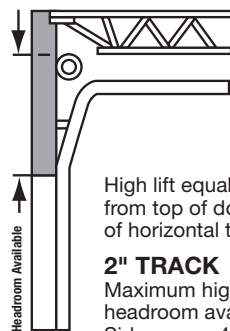

High lift equals distance from top of door to bottom of horizontal track.

### 2" TRACK

Maximum high lift equals headroom available minus 14".  
 Sideroom = 4-1/2" Required

### 3" TRACK

Maximum high lift equals headroom available minus 15".  
 Sideroom = 5-1/2" Required  
*(Minimum high lift = 12" Required)*

## ROOF PITCH

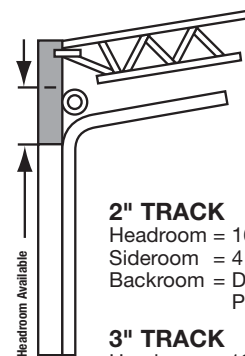

### 2" TRACK

Headroom = 16" Required  
 Sideroom = 4-1/2" Required  
 Backroom = Door Height  
 Plus 23" Required

### 3" TRACK

Headroom = 18" Required  
 Sideroom = 5-1/2" Required  
 Backroom = Door Height  
 Plus 25" Required

Headroom = Top of door to nearest obstruction (truss)

**NOTE:** Up to 4" of additional headroom may be required for a trolley door opener.

## HOW TO MEASURE YOUR DOOR

1. Measure existing door width and height in feet and inches. This determines the size of door needed. The rough opening should be the same size as the door.

Width: \_\_\_\_\_

Height: \_\_\_\_\_

2. Measure for sideroom: 3-3/4" is required on each side for installation of the vertical track for standard extension or torsion springs, or EZ-SET® torsion spring. 5-1/2" is required for EZ-SET® extension spring.

Sideroom: \_\_\_\_\_

3. Measure area labeled "headroom" – distance between the top of the door opening (jamb header) and the ceiling or lowest obstruction (e.g., opener, beams or light fixtures). 10" is required for standard installation of extension springs and EZ-SET® extension spring; 12" on standard torsion springs and EZ-SET® torsion spring. 14" of headroom required for carriage house doors. If you have restricted headroom, special hardware is available. Low headroom hardware is available to reduce requirement to as low as 4-1/2" (minimum with standard extension spring or EZ-SET® extension spring). EZ-SET® torsion spring low headroom requirement is 9-1/2". Note: If door height extends above the opening, the headroom measurement should be adjusted accordingly.

Existing headroom: \_\_\_\_\_

Headroom needed: \_\_\_\_\_

4. Measure area labeled "backroom" – distance is measured from the garage door opening toward the back wall of the garage.

Backroom: \_\_\_\_\_

Common garage door sizes include 8' wide x 7' high, 9' wide x 7' high, and 16' wide x 7' high. Holmes manufactures most doors in nearly any size you require.

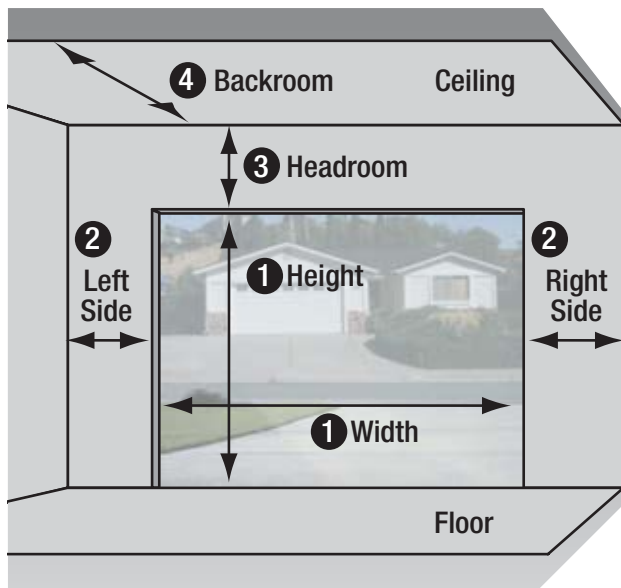

### HOW TO MEASURE DIAGRAM



For answers about choosing, installing and maintaining Holmes Garage Doors, visit us at [www.holmesgaragedoor.com](http://www.holmesgaragedoor.com) or call the Holmes Helpline® at 800-557-0488.



In the interest of better quality and value, we are continually improving and updating our products. Consequently, photos, illustrations and available options may sometimes differ from present models.