

# *Roll Track Sliding Doors*



# Roll Track & Sliding Doors Index

Round Keyhole Track.....	DRT3	395 Big Bottom Rail.....	DRT8
Pendant Bolt Trolleys.....	DRT3	201 Bottom Rail.....	DRT8
Double Truck Trolleys.....	DRT3	Door Seals.....	DRT8
Strap Trolleys.....	DRT3	391 Big Side Rail.....	DRT9
Face Mount Brackets.....	DRT4	Side Rail.....	DRT9
Universal Double Bracket.....	DRT4	Side Connector Rail.....	DRT9
Universal Bolt Bracket & Adapters.....	DRT4	Big Side Connector Rail.....	DRT9
Universal Brackets.....	DRT4	235 Steel Girt (Horizontal).....	DRT10
Splice Collar.....	DRT5	Big Guide Rail.....	DRT10
End Cap.....	DRT5	Bottom Guide Rail.....	DRT10
Adjustable Door Stop.....	DRT5	Square Track.....	DRT14
Non Adjustable Door Stop.....	DRT5	Square Track Face Mount.....	DRT14
Jamb Mount Door Stop.....	DRT5	Square Track Top Mount.....	DRT14
Chain Snugger.....	DRT6	Square Track Brackets.....	DRT14
Latches.....	DRT6	Square Track Double Brackets.....	DRT14
Locking Jamb Latch.....	DRT6	Adjustable Square Track Trolleys.....	DRT15
Door Pull.....	DRT6	Square Track Bolt Trolleys.....	DRT15
Adjustable Door Guide/Stop.....	DRT7	Square Track Replacement Trolley.....	DRT15
Floor Mount Door Guide/Stop.....	DRT7		
Center Door Guide.....	DRT7		
Stay Roller.....	DRT7		
Bottom Rail for Guide.....	DRT8		



## Round Keyhole Track

Keyhole track offers versatility, strength and ease of use. This adaptable track style can be used with any sliding door variety or bracket type – and installs with a simple connection of brackets into keyholes before mounting.

### Features:

- Keyhole Track can be utilized in both wood and metal frame construction for commercial, agriculture and metal building projects.
- When paired with available Delrin wheel trolleys, Keyhole Track can manage sliding doors weighing up to 600 pounds.
- Choose from a variety of bracket styles to accommodate track cover additions on doors up to 2-½" thick.
- Cylindrical design allows for self-cleaning and aligning with every use, positioning trolleys in the track's center and pushing away any dirt or debris build-up.

Part#	Description	Size
TCB8	Round Track - 14 ga Galvanized	8'
TCB10	Round Track - 14 ga Galvanized	10'
TCB12	Round Track - 14 ga Galvanized	12'
TCB14	Round Track - 14 ga Galvanized	14'
TCB16	Round Track - 14 ga Galvanized	16'
TCB18	Round Track - 14 ga Galvanized	18'
TCB20	Round Track - 14 ga Galvanized	20'



## Pendant Bolt Trolleys

The Pendant Bolt installs through the top of the horizontal, allowing for easy adjustment and a perfect fit. For maximum flexibility, the offset bolt version offers four directions of adjustment: up, down, in and out.

Part#	Description	Size
T5302	Derlin Bolt Trolley	9"
T53026	Derlin Bolt Trolley - 4 Way Adjustable Pendant	6-1/2"



## Double Truck Trolleys

Built to handle the heaviest sliding door panels, Double Truck Trolleys are the perfect choice for steel frame doors on Heavy Duty Tubular Track with Universal Bracketry.

### Features

- The product design features four wheels per trolley, allowing it to support door weights up to 1200 pounds. Brackets spaced every 12" on center.
- An optional plate sits just below the top girt, preventing the bolt hole from distorting.

Part#	Description	Size
TTTR	Derlin Double Truck Trolley	9"



T714876

T5330

T5332

## Strap Trolleys

Strap Trolleys attach to the front face of wood panel doors, with bolts that go through the panel for a solid hold.

Part#	Description
T714876	Derlin Trolley With Front & Back Strap - Includes End Caps
T5330	Strap Trolleys for Round Track - Top Adjustable - Includes End Caps
T5332	Side Bolt Trolley for Round Track



TTC



TFB

## Face Mount Brackets

Designed for use on CannonBall's Keyhole Track line, Face Mount Brackets contain an integral rivet that interlocks into the keyhole slot. Simply tap the bracket into each slot and mount to the face of the header board.

### Features:

- Simple assembly provides an easy way to install track on your building project.
- Use 1 bracket for every 2 feet of track.

Part#	Description
TTC	Track & Cover Bracket
TFB	Face Mount Bracket - (no cover)



## Universal Double Bracket

The Universal Double Bracket – an ideal choice for double track runs – allows two lengths of Heavy Duty or Keyhole track to be installed in parallel for bypass sliding doors.

### Features:

- Like the Universal Side Bracket, the Universal Double supports doors with weights over 600 pounds.
- Highly recommended for bypass sliding door configurations.
- The versatile design of the bracket allows for use as an end bracket, intermediate bracket or splice collar – depending on your building project's needs.

Part#	Description
TCBSBD	Double Side Bracket



TCBBHB



TSB



TTB



T5151FLASH

## Universal Bolt Bracket & Adapters

Created to bridge post frame components into metal building projects, the Universal Bolt Bracket allow builders to convert Keyhole Track into Bolt Hung Track functionality.

Part#	Description	Size
TCBBHB	Bolt Hung Bracket 1/2" Bolt Welded to Loop Bracket	
TSB	Stud Bolts for Triangle Brackets with 2-3/8" Flat Washer	1-3/8"
TTB	Triangle Bracket with 2 Stud Bolts	
T5151FLASH	Double Flashing Brackets	



TCBSB



TCBCB

## Universal Brackets

Designed for use on heavy weight sliding door projects utilizing Keyhole Track varieties, Universal Side Brackets and Universal Ceiling Brackets mount easily.

### Features:

- Universal Ceiling Brackets can be utilized to mount directly to a ceiling beam or truss for added flexibility in tight spaces with limited head room.
- The versatile design of these brackets allow for use as end brackets, intermediate brackets, or splice collars.
- Both Universal Brackets support sliding doors with weights over 600 pounds (when used in conjunction with appropriate Heavy Duty Track and spaced every foot on center).

Part#	Description
TCBSB	Side Bracket - Not Keyhole
TCBCB	Ceiling Bracket - Not Keyhole



## Splice Collar

Connects track lengths together to make a single, elongated track. NOTE: Shorter track lengths utilizing Splice Collars save on shipping and install easier than long track lengths.

Part#	Description
TCBS	Splice Collar

Splice Collar

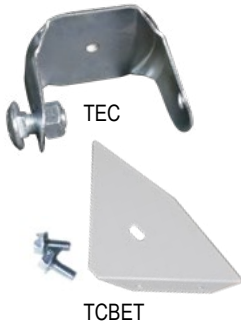

## End Cap

Attaches to open ends of track, preventing birds from nesting as well as dirt and debris build-up. NOTE: End Caps cannot be used as door stops.

Part#	Description
TEC	End Cap w. Bolt
TCBET	White Face Mount Cover End Trim - Pair

End Cap



## Adjustable Door Stop

Prevents door panels from opening or closing further than a predefined stopping point.

Part#	Description
TADJ	White Adjustable Door Stop Bumper
TADJBG	Galvanized Adjustable Door Stop Bumper

Door Stops



## Non Adjustable Door Stop

Prevents door panels from opening or closing further than a predefined stopping point

Part#	Description
TDS	Galvanized Non Adjustable Door Stop Bumper



## Jamb Mount Door Stop

Part#	Description
TJMS	Galvanized Jamb Mount Stop

## Snugger



### Chain Snugger

Prevents door panels from moving or rattling when closed and tightens as the door moves. Available in several styles based on intended use.

Part#	Description
TCS	Chain Snugger for Sliding Doors

## Latches

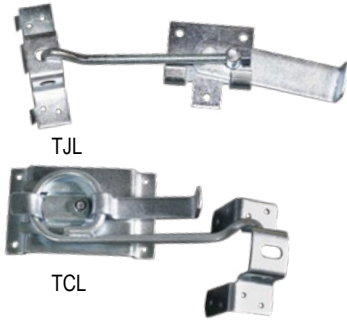

### Latches

Locks doors from the inside and pulls panels tighter against the building to reduce rattle.

Part#	Description
TJL	Adjustable Jamb Latch
TCL	Cam Latch

### Locking Jamb Latch

Can be locked with pad lock.

Part#	Description
TJLOS	Outside Handle Jamb latch

## Door Pull



### Door Pull

Assists with door opening and closing; a handle attached to door panels.

Part#	Description
TPW	White Door Pull Handle
TPG	Galvanized Door Pull Handle



### Adjustable Door Guide/Stop

Guides the door along the building, reduces the amount of door sway and prevents opening or closing beyond a predefined stopping point.

Part#	Description
TDGSW	White Adjustable Door Guide/Stop
TDGSG	Galvanized Adjustable Door Guide/Stop



### Floor Mount Door Guide/Stop

Part#	Description
T322	Pair 322 Floor Mount Guide

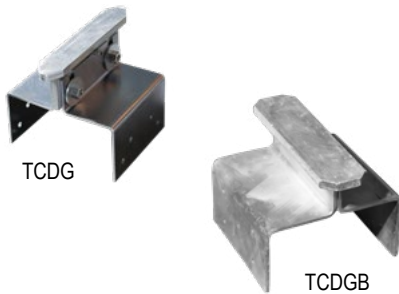

### Center Door Guide

Part#	Description
TCDG	Center Door Guide for on Post
TCDGB	Big Center Door Guide for on Post



### Stay Roller

Functions similarly to a guide rail, but recommended for Kwik Frame Door Systems or solid wood panel doors smaller than 140 sq. ft.

Part#	Description
TSMS	Small Stay Roller
TLGS	Galvanized Adjustable Large Stay Roller
N131524	Stay Roller With Lag and Shield

## Bottom Rails



### Bottom Rail for Guide

Part#	Description	Length
TBRG8	White Bottom Rail for Guide for Sliding Doors	8'
TBRG10	White Bottom Rail for Guide for Sliding Doors	10'
TBRG12	White Bottom Rail for Guide for Sliding Doors	12'
TBRG14	White Bottom Rail for Guide for Sliding Doors	14'
TBRG16	White Bottom Rail for Guide for Sliding Doors	16'
TBRG20	White Bottom Rail for Guide for Sliding Doors	20'

### 395 Big Bottom Rail

Part#	Description	Size	Length
TBRGB10	# 395 - Big Bottom Rail for Guide for Sliding Doors	3-1/2"	10'
TBRGB12	# 395 - Big Bottom Rail for Guide for Sliding Doors	3-1/2"	12'
TBRGB14	# 395 - Big Bottom Rail for Guide for Sliding Doors	3-1/2"	14'
TBRGB16	# 395 - Big Bottom Rail for Guide for Sliding Doors	3-1/2"	16'
TBRGB18	# 395 - Big Bottom Rail for Guide for Sliding Doors	3-1/2"	18'
TBRGB20	# 395 - Big Bottom Rail for Guide for Sliding Doors	3-1/2"	20'

### 201 Bottom Rail

Part#	Description	Length
TBR8	White # 201 - Bottom Rail for Sliding Doors	8'
TBR8B	Brown # 201 - Bottom Rail for Sliding Doors	8'
TBR10	White # 201 - Bottom Rail for Sliding Doors	10'
TBR10B	Brown # 201 - Bottom Rail for Sliding Doors	10'
TBR12	White # 201 - Bottom Rail for Sliding Doors	12'
TBR12B	Brown # 201 - Bottom Rail for Sliding Doors	12'
TBR14	White # 201 - Bottom Rail for Sliding Doors	14'
TBR14B	Brown # 201 - Bottom Rail for Sliding Doors	14'
TBR16	White # 201 - Bottom Rail for Sliding Doors	16'
TBR16B	Brown # 201 - Bottom Rail for Sliding Doors	16'
TBR20	White # 201 - Bottom Rail for Sliding Doors	20'

## Door Seals



### Door Seals

Part#	Description	Size
TWSSR	White Vinyl Weather Strip for Side Rails	1-1/4"
TWBSR	White Vinyl Weather Strip for #244 Bottom Rails	2"
TBS	Black Brush Seal Strip for #244 Bottom Rails	





### 391 Big Side Rail

Part#	Description	Size	Length
TSRB12	# 391 - Big Side Rail for Sliding Doors	3-1/2"	12'
TSRB14	# 391 - Big Side Rail for Sliding Doors	3-1/2"	14'
TSRB16	# 391 - Big Side Rail for Sliding Doors	3-1/2"	16'
TSRB20	# 391 - Big Side Rail for Sliding Doors	3-1/2"	20'



### Side Rail

Part#	Description	Length
TSR8	White - Side Rail for Sliding Doors	8'
TSR8B	Brown - Side Rail for Sliding Doors	8'
TSR10	White - Side Rail for Sliding Doors	10'
TSR10B	Brown - Side Rail for Sliding Doors	10'
TSR12	White - Side Rail for Sliding Doors	12'
TSR12B	Brown - Side Rail for Sliding Doors	12'
TSR14	White - Side Rail for Sliding Doors	14'
TSR14B	Brown - Side Rail for Sliding Doors	14'
TSR16	White - Side Rail for Sliding Doors	16'
TSR16B	Brown - Side Rail for Sliding Doors	16'
TSR20	White - Side Rail for Sliding Doors	20'



### Side Connector Rail

Part#	Description	Length
TCR8	White - Side Connector Rail for Sliding Doors	8'
TCR8B	Brown - Side Connector Rail for Sliding Doors	8'
TCR10	White - Side Connector Rail for Sliding Doors	10'
TCR10B	Brown - Side Connector Rail for Sliding Doors	10'
TCR12	White - Side Connector Rail for Sliding Doors	12'
TCR12B	Brown - Side Connector Rail for Sliding Doors	12'
TCR14	White - Side Connector Rail for Sliding Doors	14'
TCR14B	Brown - Side Connector Rail for Sliding Doors	14'
TCR16	White - Side Connector Rail for Sliding Doors	16'
TCR16B	Brown - Side Connector Rail for Sliding Doors	16'
TCR20	White - Side Connector Rail for Sliding Doors	20'



### Big Side Connector Rail

Part#	Description	Size	Length
TCRB12	White - Big Side Connector Rail for Sliding Doors	3-1/2"	12'
TCRB14	White - Big Side Connector Rail for Sliding Doors	3-1/2"	14'
TCRB16	White - Big Side Connector Rail for Sliding Doors	3-1/2"	16'
TCRB20	White - Big Side Connector Rail for Sliding Doors	3-1/2"	20'

## Steel Girt



### 235 Steel Girt (Horizontal)

Provides horizontal support on sliding door frames. Steel girts are manufactured with 20-gauge galvanized steel for long lasting, light weight, rust-free door.

Part#	Description	Size	Length
TSG8	# 235 - 20 Gauge Steel Girts for Sliding Doors	1.5" x 3.5"	8'
TSG10	# 235 - 20 Gauge Steel Girts for Sliding Doors	1.5" x 3.5"	10'
TSG12	# 235 - 20 Gauge Steel Girts for Sliding Doors	1.5" x 3.5"	12'
TSG14	# 235 - 20 Gauge Steel Girts for Sliding Doors	1.5" x 3.5"	14'
TSG16	# 235 - 20 Gauge Steel Girts for Sliding Doors	1.5" x 3.5"	16'
TSG18	# 235 - 20 Gauge Steel Girts for Sliding Doors	1.5" x 3.5"	18'
TSG20	# 235 - 20 Gauge Steel Girts for Sliding Doors	1.5" x 3.5"	20'

## Guide Rails



### Big Guide Rail

Part#	Description	Length
TGRB6	Big Guide Rail with 3 Brackets for Sliding Doors	6'
TGRB8	Big Guide Rail with 3 Brackets for Sliding Doors	8'
TGRB10	Big Guide Rail with 3 Brackets for Sliding Doors	10'

### Bottom Guide Rail

Reduces the amount of door sway, helps prevent wind damage and provides easier door operation. Stay Guide lengths should measure 60% of the door panel width.

Part#	Description	Size
TGR5	Guide Rail System with 2 Brackets	5'
TGR10	Guide Rail System with 3 Brackets	10'

# Single Slider

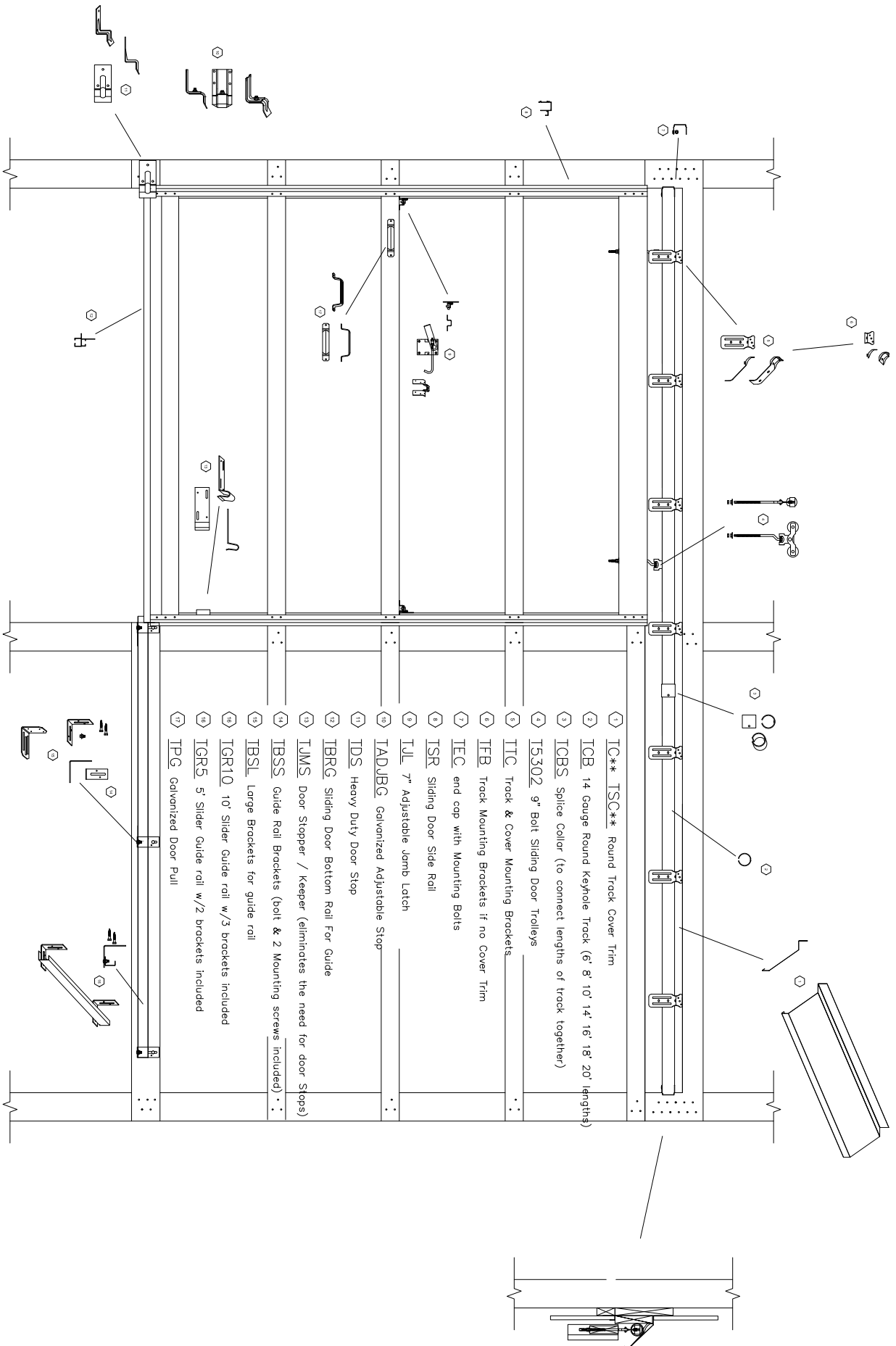

- ① IC\*\* TSC\*\* Round Track Cover Trim
- ② ICB 14 Gauge Round Keyhole Track (6' 8' 10' 14' 16' 18' 20' lengths)
- ③ ICBS Splice Collar (to connect lengths of track together)
- ④ I5302 9" Bolt Sliding Door Trolleys
- ⑤ ITC Track & Cover Mounting Brackets
- ⑥ IFB Track Mounting Brackets if no Cover Trim
- ⑦ TEC end cap with Mounting Bolts
- ⑧ ISR Sliding Door Side Rail
- ⑨ IJA 7" Adjustable Jamb Latch
- ⑩ IADJBG Galvanized Adjustable Stop
- ⑪ IDS Heavy Duty Door Stop
- ⑫ IBRG Sliding Door Bottom Rail For Guide
- ⑬ IJMS Door Stopper / Keeper (eliminates the need for door Stops)
- ⑭ IBSS Guide Roll Brackets (bolt & 2 Mounting screws included)
- ⑮ IBSL Large Brackets for guide rail
- ⑯ IGR10 10" Slider Guide rail w/3 brackets included
- ⑰ IGR5 5" Slider Guide rail w/2 brackets included
- ⑱ IPG Galvanized Door Pull

# Double Slider

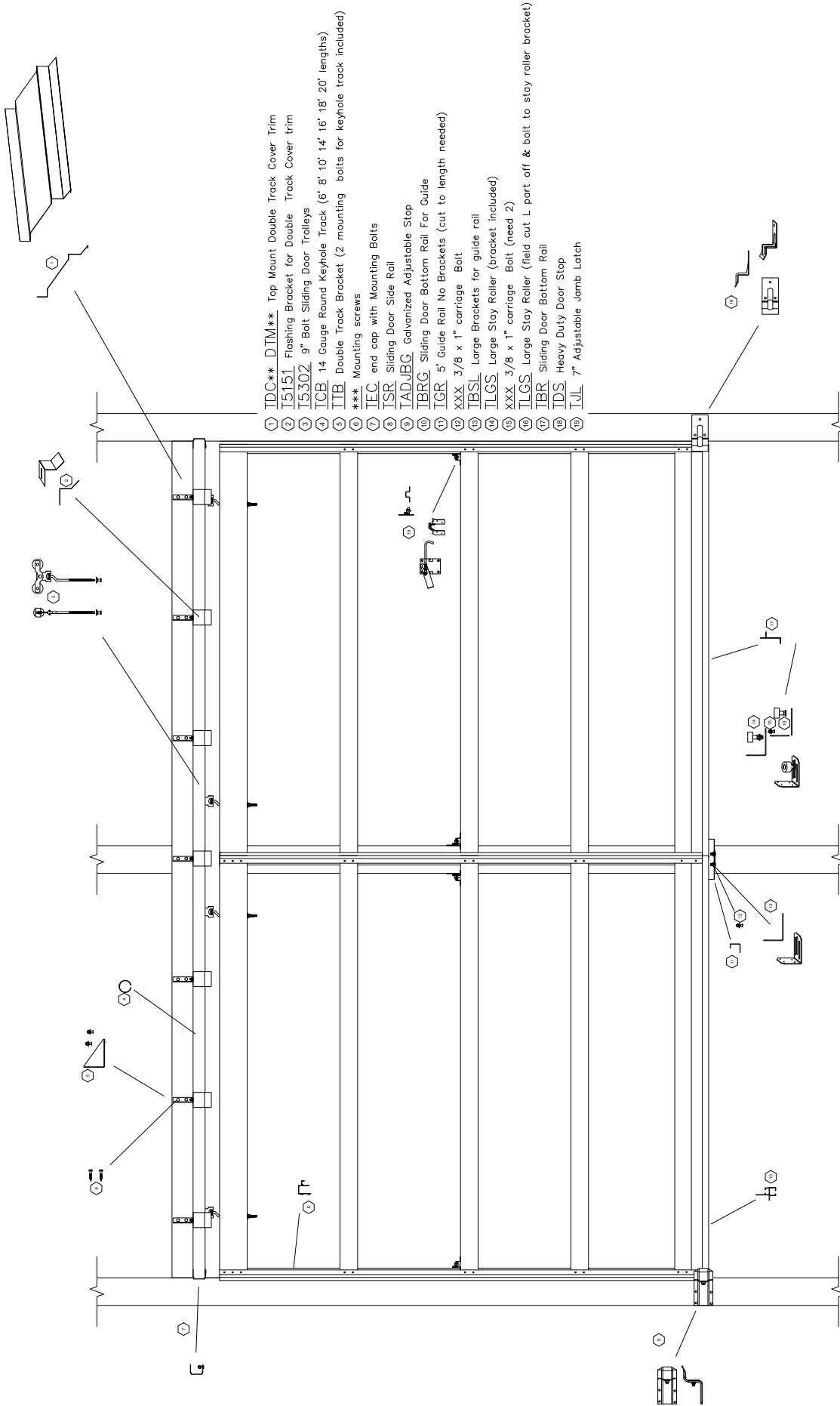

# *Square Track Sliding Doors*



## Square Track

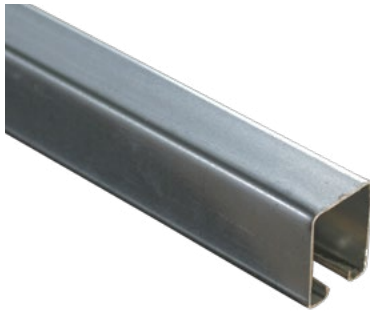

## Square Track

Part#	Description	Length
TSQ8	Galvanized Square Track - 16 Gauge	8'
TSQ10	Galvanized Square Track - 16 Gauge	10'
TSQ12	Galvanized Square Track - 16 Gauge	12'
TSQ14	Galvanized Square Track - 16 Gauge	14'
TSQ16	Galvanized Square Track - 16 Gauge	16'
TSQ20	Galvanized Square Track - 16 Gauge	20'



## Square Track Face Mount

Part#	Description	Length
TGC8	Galvanized Covered Square Track Face Mount - 16 Gauge	8'
TGC10	Galvanized Covered Square Track Face Mount - 16 Gauge	10'
TGC12	Galvanized Covered Square Track Face Mount - 16 Gauge	12'
TGC14	Galvanized Covered Square Track Face Mount - 16 Gauge	14'
TGC16	Galvanized Covered Square Track Face Mount - 16 Gauge	16'
TGC18	Galvanized Covered Square Track Face Mount - 16 Gauge	18'
TGC20	Galvanized Covered Square Track Face Mount - 16 Gauge	20'



## Square Track Top Mount

Part#	Description	Length
TWC8	White Covered Square Track Top Mount - 16 Gauge	8'
TWC10	White Covered Square Track Top Mount - 16 Gauge	10'
TWC12	White Covered Square Track Top Mount - 16 Gauge	12'
TWC14	White Covered Square Track Top Mount - 16 Gauge	14'
TWC16	White Covered Square Track Top Mount - 16 Gauge	16'
TWC20	White Covered Square Track Top Mount - 16 Gauge	20'

## Brackets



TSSB



TSSSB

## Square Track Brackets

Part#	Description
TSSB	Square Track Bracket
TSSSB	Square Track Splice Bracket



TDB



TDBS

## Square Track Double Brackets

Part#	Description
TDB	Square Track Double Bracket
TDBS	Square Track Double Splice Bracket

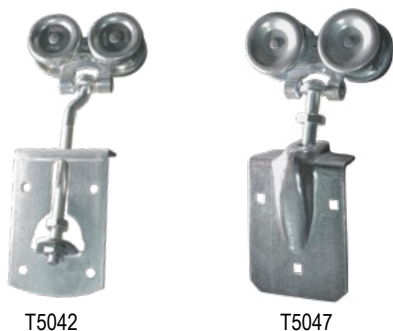

### Adjustable Square Track Trolleys

Part#	Description	Lbs. Rating
T35LB	Side Adjustable Square Track Trolleys - Pair	35 lbs. each
T5042	5042 Side Adjustable Square Track Trolleys - Pair - Includes End Caps	
T5047	5047 Top Adjustable Square Track Trolleys - Pair	32 lbs. each



### Square Track Bolt Trolleys

Part#	Description	Size
T38T9	Square Track Bolt Trolleys w/ Threaded Bolt - Pair	9"
T5022	Square Track Bolt Trolleys w/ Delrin Bearings - Pair - Includes End Caps	9"



### Square Track Replacement Trolley

Part#	Description	Lbs. Rating
T32REPLACE	Square Track Replacement Trolleys	32 lbs. each

# Square Slider

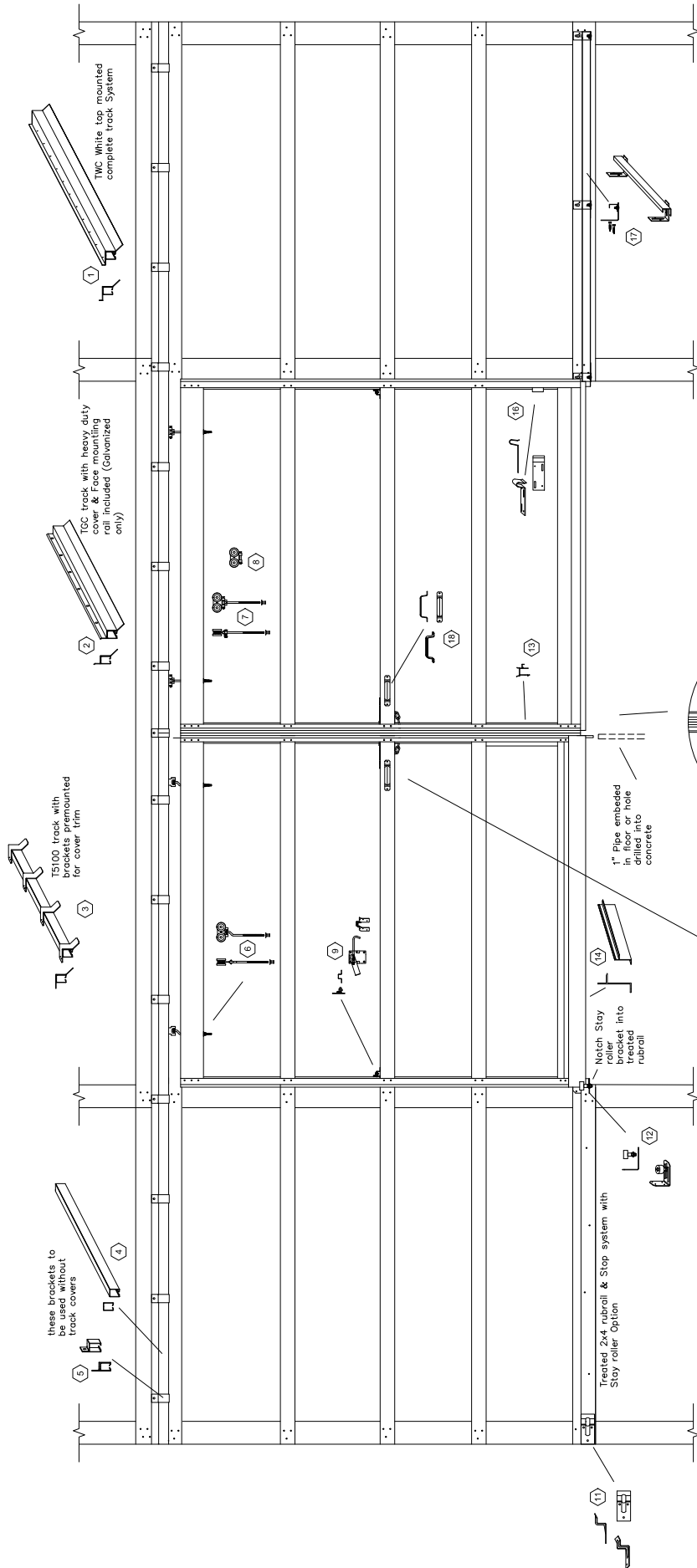

- ① TWC White Top Mount Square track system (8' 10' 12' 16' 20' Length)
- ② TGC Galvanized Covered Face Mount track system (8' 10' 14' 16' 20' lengths)
- ③ T5100 Square track system With Track & Cover brackets preinstalled
- ④ TSSB Plain 16 Gauge square track (needs mounting brackets)
- ⑤ TSSB Square Track Hanger
- ⑥ T5022 Square 9" bolt trolley
- ⑦ T3819 Square Trolley (Lawrence)
- ⑧ T32REPLACE Replacement trolley for T3819
- ⑨ TJL 7" Adjustable Jamb Latch
- ⑩ TCS Chain Snugger
- ⑪ TDS Heavy Duty Door Stop
- ⑫ TLGS Large Stay Roller
- ⑬ TCR Connector Rail
- ⑭ TBR Bottom Rail
- ⑮ TCANE Cane Bolt
- ⑯ TJMS Door Keeper Stopper (jamb mounted door stop)
- ⑰ TGR10 10' Slider Guide rail w/3 brackets included
- ⑱ TPC Galvanized Door Pull
- ⑲ TPW White Door Pull