

## LOCKSETS

**LC3600 HEAVY-DUTY**  
Grade 3 Cylindrical Leverset



**KC3600 HEAVY-DUTY**  
Grade 3 Cylindrical Knobset



**DB1000 DEADBOLT**  
Heavy-Duty Grade 1

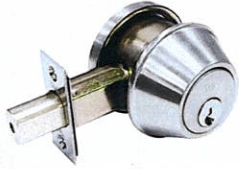

**DB2000 / DB2400 DEADBOLTS**  
Grade 2



**INDICATOR DEADBOLT**  
Grade 2



## DOORS & FRAMES

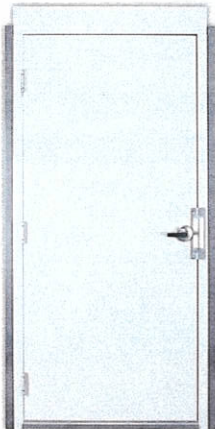

Hollow Metal Doors

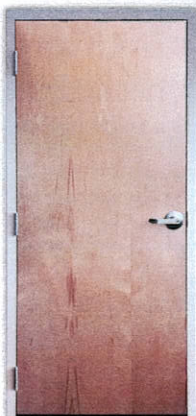

Wood Doors



Steel Frames



Lite Kits

## HINGES & DOOR TRIM

**H4545 HINGES**  
4 1/2" Square, Plain Bearing, Ball Bearing, Non-Removable Pin

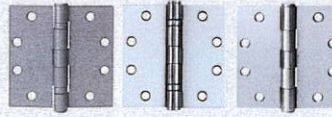

### DOOR TRIM



Strikes



Door Bumpers



Door Stops



Kickdowns

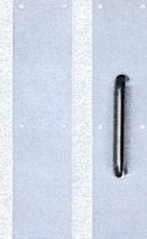

Push & Pull Plates



Door Guards



Surface Bolts



Kickplates

## TELL SPECIAL ORDER PROGRAM

Offering a **One-Stop-Shop** for all your commercial hardware needs that include: wood and hollow metal doors, locksets, closers, exits and trim accessories. We can cover the whole job, from small-scale to larger ground-up commercial building projects.

### HOW IT WORKS!

Review our Tell Catalog for commercial door and hardware products available or visit [www.tellmfg.com](http://www.tellmfg.com). It's as easy as:

1. Find the products you need for the project
2. Talk with customer service to review and estimate the job
3. Place the order

If you have any questions, please feel free to contact our customer service department.

Look To A.B. Martin Roofing Supply, LLC  
For Any Special Order Requests.



# COMMERCIAL HARDWARE

For Your Commercial Door & Hardware Needs.

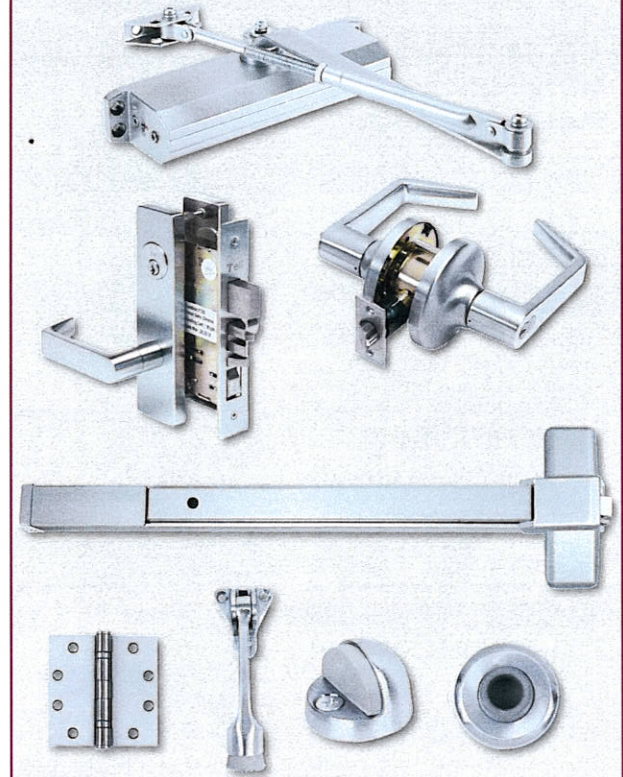

800.433.4047 | [www.tellmfg.com](http://www.tellmfg.com)

**A.B. Martin Roofing Supply, LLC**

82 Garden Spot Road, Ephrata, PA 17522

717-445-6885

## LOCKSETS

**LC1200 HEAVY-DUTY**  
Grade 1 Cylindrical Leverset



**KC1100 HEAVY-DUTY**  
Grade 1 Cylindrical Knobset

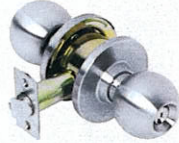

**LT2000 LIGHT-DUTY**  
Grade 2 Tubular Leverset

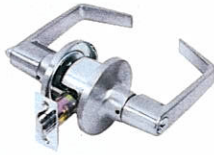

**KT2100 LIGHT-DUTY**  
Grade 2 Tubular Knobset



**KC2300 HEAVY-DUTY**  
Grade 2 Cylindrical Knobset



**LC2400 HEAVY-DUTY**  
Grade 2 Cylindrical Leverset



**LC2600 STANDARD-DUTY**  
Grade 2 Cylindrical Leverset

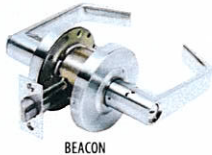

BEACON

**LC2700 STANDARD-DUTY**  
Grade 2 Cylindrical  
Interconnected Leverset

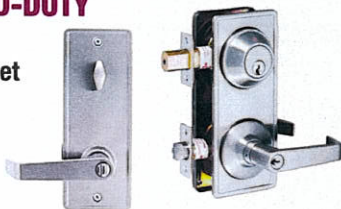

## DOOR CLOSERS

**500 SERIES**  
Standard-Duty Grade 3  
Surface Applied

- Adjustable Sizes: 1-4



**600 SERIES**  
Heavy-Duty Grade 1  
Surface Applied

- Adjustable Sizes:  
1-4 and 3-6

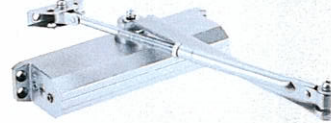

**700 SERIES**  
Heavy-Duty Grade 1  
Surface Applied

- Adjustable Sizes: 1-6

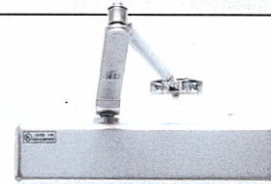

**800 SERIES**  
Heavy-Duty Grade 1  
Surface Applied

- Spring Power Adjustable Sizes: 1-6

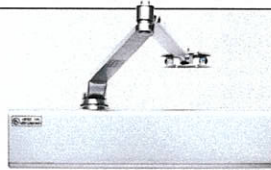

**900 SERIES**  
Heavy-Duty Grade 1  
Surface Applied

- Adjustable Sizes: 1-6

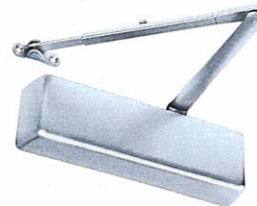

**1000/2000 SERIES**  
Residential Ivory or Brown

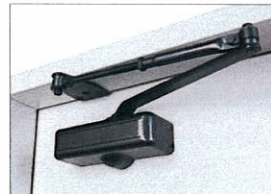

## EXIT DEVICES

**7300 SERIES** Grade 1



**7400 SERIES** Grade 1 Vertical Rod



- Fits 28" to 36" Doors
- Complies with ANSI A156.3, 1994, UL/ULC listed
- Accommodates Wood or Metal Doors
- 10 Year Limited

**8300 SERIES** Grade 1

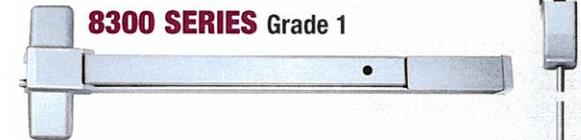

**8400 SERIES** Grade 1 Vertical Rod



- Fits 28" to 36" Doors
- Complies with ANSI A156.3, 1994, UL/ULC listed
- Accommodates Wood or Metal Doors
- 10 Year Limited

**9500 SERIES** Grade 1



**9400 SERIES** Grade 1 Vertical Rod



- Fits 30" to 36" Doors
- Complies with ANSI A156.3, 1994, UL/ULC Listed
- Accommodates Wood or Metal Doors with Thru Bolts
- 10 Year Limited

**EXIT TRIMS**



Blank Pull

Entry Lever

Escutcheon Lever Trim